

Instruction Manual

DC Bias Tester

SY-960

DC Bias Source

SY-961

AC Blocker

SY-962





IWATSU TEST INSTRUMENTS CORPORATION



Introduction

- ◇ Thank you for purchasing this IWATSU instrument and please regularly use Iwatsu instruments lastingly in future.
- ◇ Please read this manual before using units SY-960, SY-961, and SY-962 (hereinafter collectively called “this instrument”), then keep the manual handy for future reference.
- ◇ This manual describes operating precautions, operating procedure, operation examples, and specifications. For the main unit of the B-H Analyzer, please refer to its instruction manual.

Safety Precautions

To ensure safe operation of this instrument and to prevent injury to the user or damage to property, read and carefully observe the warnings  and cautions  in the following sections

Definition of warnings and cautions used in this manual

 Warnings	Incorrect operation or failure to observe the warning may result in death or serious injury.
 Cautions	Incorrect operation or failure to observe the caution may result in bodily injury or damage to the instrument.

Notes

- ◇ Parts of the contents of this manual may be modified without notice for improvements in specifications and functions.
- ◇ Reproduction or reprinting of the contents of this manual without prior permission from IWATSU is prohibited.
- ◇ All the product and brand names in this document are registered trademarks of their respective companies and individuals, and are used here for identification purpose.
- ◇ If any question about this instrument arises, contact Iwatsu at the address listed at the end of this manual or our sales distributors.

History

- ◇ September 2015: 1st edition
- ◇ May 2016: 2nd edition

Warnings

- **Do not use in an environment with explosive gases.**

It may cause an explosion.

- **If you notice smoke, foul odor or abnormal noise, immediately power off this instrument and remove the power plug from the receptacle.**

Continued use under these circumstances may result in an electric shock or fire. Turn off the main power switch on the rear of SY-961 (○ side), and remove the power plug of SY-961 from the receptacle. Then contact Iwatsu office or our sales distributors for repair. Do not attempt to repair this instrument yourself.

- **Make sure no water gets on or inside this instrument.**

Do not use this instrument if wet, otherwise an electric shock or fire could occur. If water gets on or inside this instrument, turn off the main power switch on the rear of SY-961 (○ side), and remove the power plug of SY-961 from the receptacle. Then contact Iwatsu office or our sales distributors for repair.

- **Do not place this instrument on an unstable support such as shaky base or inclined plane.**

Dropping or falling-down of this instrument could result in an electric shock, injury, or fire. If this instrument is dropped or its cover is broken, turn off the main power switch on the rear of SY-961 (○ side), and remove the power plug of SY-961 from the receptacle. Then contact Iwatsu office or our sales distributors for repair.

- **Do not expose this instrument to excessive vibration or shock.**

Dropping of falling-down of this instrument could result in injury.

- **Dropping of this instrument could result in injury to your body or damage to your property.**

Before carrying this instrument, remove the measurement sample and cables, close the cover, and then firmly hold it with both hands while carrying so that it does not fall.

- **Use 3-core power cord. (SY-961)**

If not, an electric shock or failure may occur.

- If power is supplied from the 2-wire receptacle using the 3-core/2-core conversion adapter, connect the ground terminal of the 3-core/2-core conversion adapter to the ground.
- If power is supplied from the 3-wire receptacle using the provided 3-core power cord, grounding is made by the ground line of the power cord.

Read the following safety information.

Read the next page.

 **Warnings** (Continued)

● **Always use this instrument with a specified power supply voltage. (SY-961)**

Otherwise, an electric shock, fire, or failure may occur. The range of operating voltage to be used is stated on the rear panel.

This instrument runs on AC power supply of single-phase, 50/60Hz, and AC100-240V.

No voltage selection is required, since this instrument automatically adapts to the power supply voltage.

● **Strictly observe items below when handling the power cord. (SY-961)**

If not, an electric shock or fire may occur. If the power cord is damaged, contact Iwatsu office or our sales distributors for repair.

- Do not modify the power cord.
- Do not forcibly bend the power cord.
- Do not twist the power cord.
- Do not bundle the power cord.
- Do not pull the power cord.
- Do not heat the power cord.
- Do not let the power cord get wet.
- Do not put heavy objects on the power cord.

● **Do not touch the plug of the power cord with wet hands. (SY-961)**

If not, an electric shock may occur.

● **Do not make metal touch the blade of the power plug. (SY-961)**

If not, an electric shock or fire may occur.

● **Do not plug too many leads into a single receptacle. (SY-961)**

If not, a fire or overheating may occur.

● **If thunder sounds, remove the power plug (SY-961) of this instrument from the receptacle and do not use it.**

It causes an electric shock, fire or failure according to the thunder.

● **Do not attempt to modify or repair this instrument.**

This may result in an electric shock, fire or failure. The user cannot repair this instrument. Do not repair this instrument opening it. Also, requests to repair the unit may be refused if unauthorized modifications have been made. Contact our sales distributors for repair. Please note not responding to the repair when the open security seal is removed, the cover is opened or the product is modified.

● **Do not use this instrument when being failed.**

If not, an electric shock or fire may occur. For a failure, contact Iwatsu office or our sales distributors for repair.

 **Warnings** (Continued)

- **Do not place any small metal objects or containers containing water or chemical on or near this instrument.**

If liquid spills or a small metal object gets in, it may cause an electric shock, fire or failure. If water/chemical/metal object gets in, turn off the main power switch on the rear of SY-961 (○ side), and remove the power plug from the receptacle. Then contact Iwatsu office or our sales distributors for repair.

- **Do not put any metallic material or inflammable object through the ventilation port. (SY-960/SY-961/SY-962)**

If any foreign object is put through the ventilation port, an electric shock, fire, or failure may occur. If any foreign object enters this instrument, turn off the main power switch on the rear of SY-961 (○ side), and remove the power plug of SY-961 from the receptacle. Then contact Iwatsu office or our sales distributors for repair.

- **Do not put any object near to the ventilation port of this instrument. (SY-960/SY-961/SY-962)**

If not, heat accumulates inside this instrument, causing an electric shock, fire, or failure.

- **Before inserting the power plug into the receptacle, confirm no dust attached to it. In addition, remove the power plug and adapter from the receptacle and inspect/clean them once a half year or a year. (SY-961)**

Dust may cause an electric shock, fire, or failure.

- **Use this instrument without fail in the joint of SY-961 and SY-962 with joint fittings of the attachment.**

The case of SY-962 is grounded with this joint. Moreover, this joint contributes to the fall prevention of SY-962 from SY-961.

- **For your safety, do not carry SY-961 and SY-962 while they are jointed.**

Doing so could result in bodily injury or property damage.

- **There may be possibility that the sample and the terminal become high temperatures while measuring, and do not touch the sample and the terminal immediately after the measurement.**

Doing so could result in bodily burn.

Read the following safety information.

Read the next page.



Cautions

- **Surely use SY-961 together with SY-960 and SY-962.**

It causes the breakdown if SY-961 is used together with equipment other than SY-960 and SY-962, or if SY-961 is used alone.

- **Connect or disconnect the power cord after turning off the main power switch on the rear of SY-961.**

Connecting or disconnecting the power cord while the main power switch is ON (I side) may result in an electric shock or failure.

- **Insert the power supply plug into the receptacle firmly. (SY-961)**

If not, an electric shock, fire, or failure may occur.

- **When disconnecting the power cord from the receptacle, pull it out by grasping the plug. (SY-961)**

Do not pull on the cord itself, as doing so may damage the cord and could result in an electric shock or fire.

- **Before moving this instrument, confirm that external connection lines such as the power cord and cables are removed.**

The power cord and cable may be damaged, causing a fire or electric shock.

- **Use 3-core power cord in accordance with the power supply voltage. (SY-961)**

If not, a fire may occur. In addition, if a 2-core power cord is used, a fire may occur.

Unless specified when purchasing this instrument, the power cord suitable for 100V system (center voltage: 100V to 120V) is attached. If the power supply voltage is 200V system (center voltage: 200V to 240V), use 3-core power cord suitable for 200V system (optional) specified by Iwatsu (rating voltage: 250V).

- **Do not apply an excessive voltage or current to the input connector.**

If not, a fire, electric shock, damage to this instrument or a sample, or failure may occur.

The maximum allowable input voltage and current of SY-960 are as follows:

Input connector	Maximum allowable input voltage or current
Between P2-P1	±200V
Between S2-S1	±200V
POWER INPUT	±200V / ±6A

- **Carefully clean the IR temperature sensor part of the SY-960 sample table.**

The IR temperature sensor of the SY-960 sample table is covered with a polyethylene sheet for protection. Do not clean it with any items other than the blower brush of the SY-960 attachment because it is easy to break.

- **Use the dedicated printed-circuit board.**

It is very dangerous to design the printed-circuit board by yourself. We offer a customized printed-circuit board. Contact Iwatsu office or our sales distributors for details.

Read the following safety information.



Cautions (Continued)

● **Do not place any object on this instrument.**

Otherwise, the cover may break and come in contact with the internal circuits, causing an electric shock, fire, or failure.

● **Always use this instrument only within the rated operating range.**

If used over the rated range, failure may occur. The allowable range is as follows:

- Only indoor use
- Operating temperature: +5°C to +35°C
- Specification guarantee temperature: 18°C to +28°C
- Operating humidity: no dew allowed below the moisture amount of 85 % RH (±35°C, non-condensation)

● **Do not expose this instrument to direct sunlight or high humidity.**

If not, heat may accumulate inside this instrument, resulting in a fire.

● **Do not place this instrument in a location with excessive moisture or dust.**

If not, an electric shock or fire may occur.

● **Do not expose this instrument to oil smoke or steam; e.g. besides cooking table or humidifier.**

A fire or electric shock may occur.

● **Do not use any damaged cable or power cord. (SY-961)**

Otherwise, an electric shock or fire may occur.

● **If this product will not be used for a long time, remove the power plug from the receptacle for safety. (SY-961)**

● **Before transporting, remove the measurement sample from this product, close the cover, and then pack with the packing material provided at the time of purchase or the equivalent or better.**

Excessive vibration or shock applied to this product during transportation may cause it to malfunction, resulting in a fire. The warranty will be voided when a failure or damage is caused by transporting the product while the sample is attached or the cover is open.

If there is not a proper packing material/ shock absorber, contact Iwatsu office or our sales distributors. When having this instrument transported by a shipping company, write "Precision Instrument - Handle With Care" on each side of the packing box.

● **When cleaning this instrument, remove the power plug from the receptacle for safety. Use dry cloth to wipe water drops away. (SY-961)**

If not, an electric shock or fire may occur.

● **This instrument is an equipment of Class A (Industrial electromagnetic environment).**

There may be a difficult possibility about keeping the electromagnetic compatibility in environments other than industrial due to conducted as well as radiated disturbances.

Avoid use in the residential areas, except when you do measures to which the user decreases the electromagnetic emissions to prevent interference because there is a possibility to cause interference for other equipment.

Checking packed materials

When receiving this instrument, check the packed materials referring to components below (for the open bale chart, see the next page). If there is a lacked item or an item damaged during transportation, immediately contact Iwatsu office or our sales distributors.

Components

○ SY-960

DC Bias Tester SY-960 main unit 1

Accessories

DCT cable (SY-963) 1

PCB1528-030 1

PCB5650-079 1

Thumbscrews for the terminal block 2

Blower brush 1

Accessories storage box 1

Instruction manual CD 1

User's Guide (A4 size) 1

○ SY-961

DC Bias Source SY-961 main unit 1

Accessories

Power cord 1

Cord strap 1

○ SY-962

AC Blocker SY-962 main unit 1

Accessories

Joint fittings 4

ACB cable L 1

ACB cable S 1

DC cable L Red / Black 1 each

DC cable S Red / Black 1 each

Open bale chart (main unit and accessories)

○SY-960

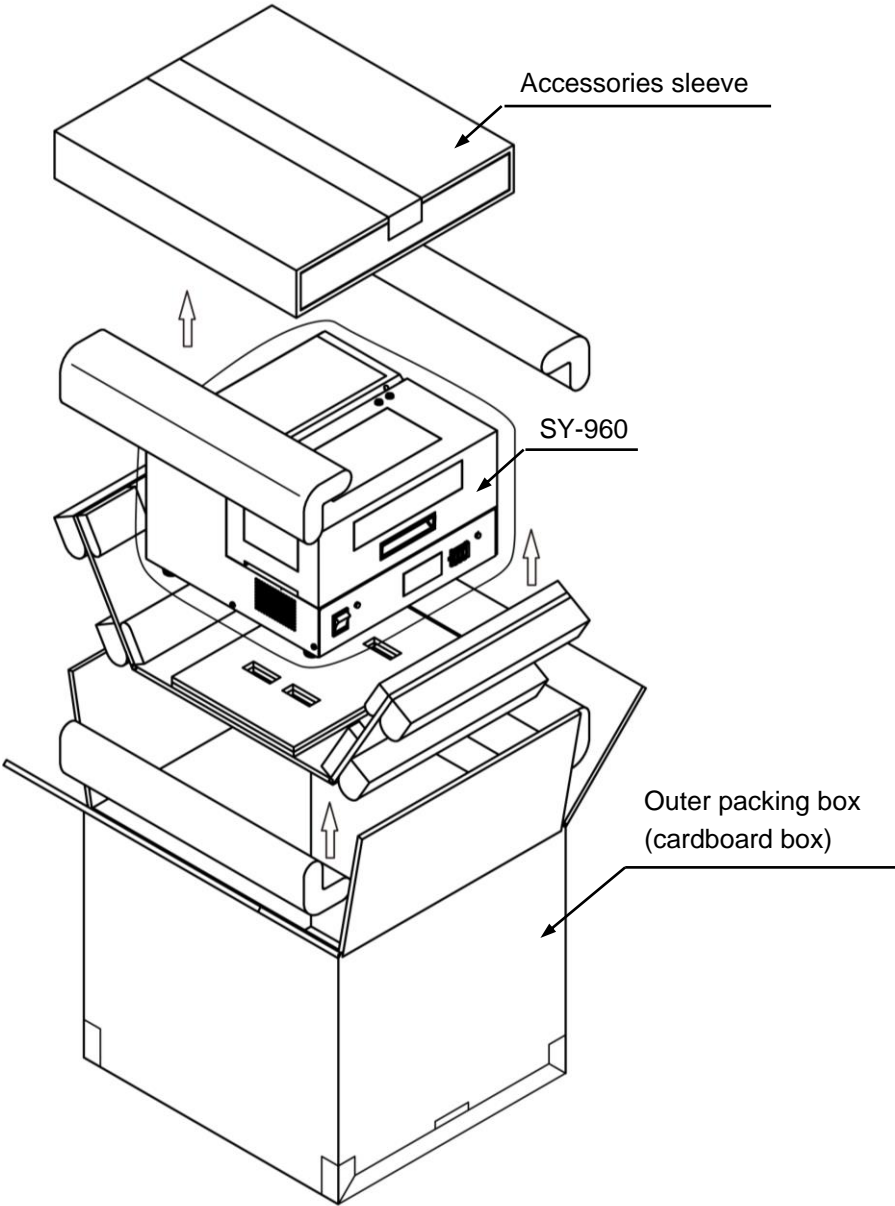

Open bale chart (main unit and accessories)

OSY-961

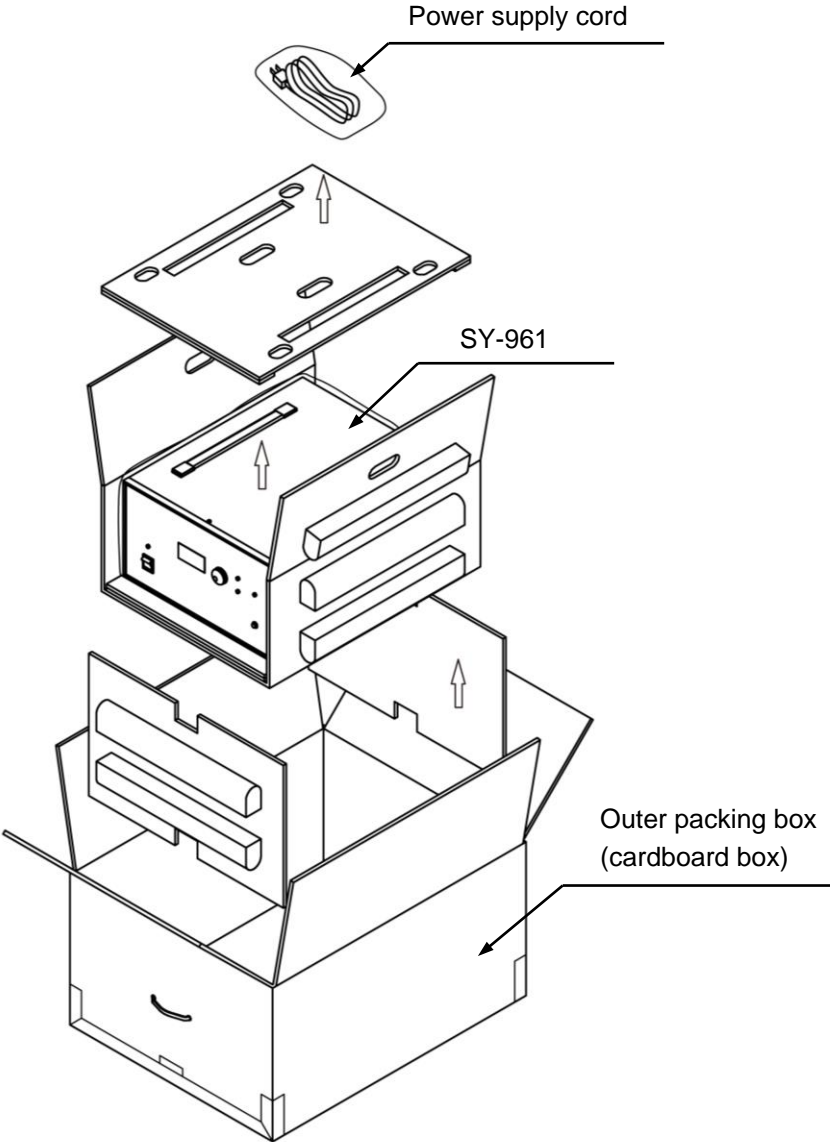

Open bale chart (main unit and accessories)

○SY-962

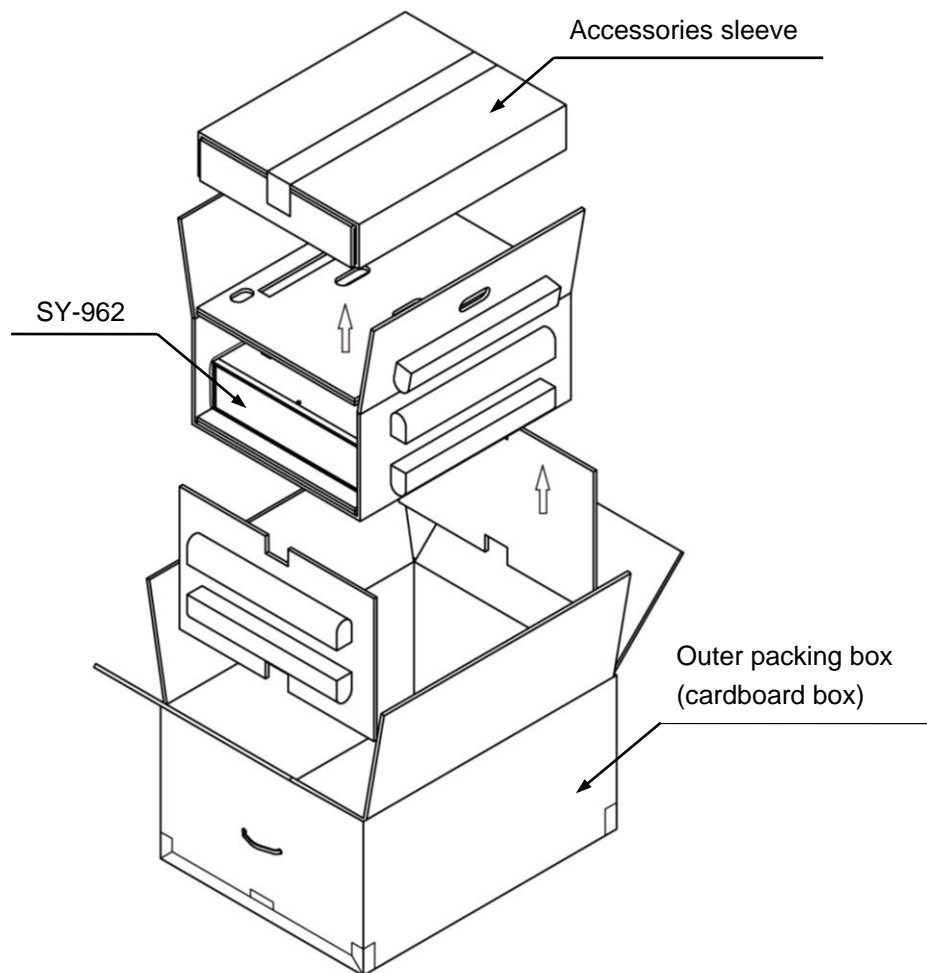

Management of product

When disposing of this instrument, it is necessary to recycle or dispose of it properly in accordance with a local law or regulation. When disposing of it, request a recycle company to dispose of it in accordance with a local law or regulation.

Repair and shipment of the product to be repaired

If a failure occurs, mail this instrument to our service center. Any failure which occurs within the term of warranty and for which Iwatsu is responsible should be repaired without any cost.

When shipping a product to be repaired, clearly write the product name, serial number (in the label on the rear of this instrument), description of the failure, and name, division, and telephone number of the responsible person.

About the open security seal

A security seal is affixed on the main unit. (Refer to 3.3 SY-960 DC BIAS TESTER Rear Panel, and 6.5 DC BIAS SOURCE SY-961 Appearance and 6.6 AC BLOCKER SY-962 Appearance.) We do not accept any repairs orders for the product if the security seal is broken.

Contents

Chapter 1 Introduction	3
■ 1.1 Overview	3
■ 1.2 Characteristics	3
■ 1.3 Notes for Handling and Installation.....	4
Chapter 2 before Measuring	5
■ 2.1 Process of Direct Current Superimposed Measurement	5
■ 2.2 Explanation of Operation of Direct Current Superimposed Measurement Circuit.....	6
■ 2.3 What must be Calculated and Checked before Starting Measurement.....	8
■ 2.4 Expressions to Calculate Measurement Values.....	12
Chapter 3 Name and Function of Each Part of Each Instrument	14
■ 3.1 SY-960 DC Bias Tester Front Panel	14
■ 3.2 SY-960 DC Bias Tester Top Panel (No Cover).....	15
■ 3.3 SY-960 DC Bias Tester Rear Panel	16
■ 3.4 SY-961 DC Bias Source Front Panel.....	17
■ 3.5 SY-961 DC Bias Source Rear Panel.....	19
■ 3.6 SY-962 AC Blocker Rear Panel.....	20
Chapter 4 Measurements	21
■ 4.1 Flow of Measurement.....	21
■ 4.2 Jointing SY-961 and SY-962	22
■ 4.3 Connecting Instrument.....	23
■ 4.4 Connecting DCT Cable SY-963	24
■ 4.5 Connecting DC Cable.....	26
■ 4.6 Connecting ACB Cable	26
■ 4.7 Turning the Power ON.....	27
■ 4.8 Turning the Power OFF.....	27
■ 4.9 Setting a Sample	28
■ 4.10 Setting the Overheat Temperature	29
■ 4.11 Checking Functions	30
■ 4.12 Selecting the DC Bias Measuring Mode.....	30
■ 4.13 Selecting a Coil Method of the Sample	30
■ 4.14 Measurement Screen	31
■ 4.15 Entering Constants of Sample.....	32
■ 4.16 Setting Measuring Conditions	33
■ 4.17 Measurement	35
■ 4.18 Switching Graph.....	36
■ 4.19 Cursor Measurement	36
■ 4.20 Enlargement / Reduction of Graph.....	36
■ 4.21 Reference Function.....	36
■ 4.22 USB Memory Output of Screen Hard Copy	36
■ 4.23 Save / Read the Data	36
Chapter 5 Maintenance	37
■ 5.1 Daily Maintenance	37
■ 5.2 Calibration.....	37
Chapter 6 Specifications	38
■ 6.1 DC Bias Tester SY-960	38
■ 6.2 DC Bias Source SY-961	39

■ 6.3 AC Blocker SY-962	39
■ 6.4 DC Bias Tester SY-960 Appearance.....	40
■ 6.5 DC Bias Source SY-961 Appearance.....	40
■ 6.6 AC Blocker SY-962 Appearance.....	41
■ 6.7 Dimension Diagram of Measuring Table.....	41
■ 6.8 Certification Standards.....	42

Chapter 1 Introduction

- This manual only explains operation of DC Bias Tester SY-960, DC Bias Source SY-961, and AC Blocker SY-962, and new functions added to B-H ANALYZER by using SY-960 to SY-962. This manual omits explanations about measurement functions that are also provided by B-H ANALYZER as standard. See Instruction Manual of the B-H ANALYZER main unit.

■ 1.1 Overview

- This instrument can measure magnetic properties of a sample under direct current superimposed, by combining with B-H ANALYZER.
 - * B-H ANALYZERS SY-8232, SY-8217, and SY-8258 are not supported.

■ 1.2 Characteristics

- This instrument provides the following characteristics:
 - (1) **Magnetic properties can be measured by superimposing direct current** over a sinusoidal wave or a pulse wave.
Especially with a pulse wave, the current flowing in the sample produces a triangular wave over which direct current is superimposed^{*1}, and the magnetic properties can be measured by a so called **chopper operation**.
^{*2} Measuring frequency can be adjusted **between 10 [kHz] and 3 [MHz] for a sinusoidal wave, between 10 [kHz] and 1 [MHz] for a pulse wave, and for Duty between 10 and 90 [%]**.
 - ^{*1}: The range of the measuring frequency f that becomes a triangular wave is limited by inductance L of the sample.
 - ^{*2}: The range of the measuring frequency f that can be correctly measured is limited by inductance L of the sample.
 - (2) **The maximum direct current superimposed is 30 [A], the maximum^{*3} compliance voltage is 10 [V], and the maximum measurement DC power voltage ripple current is 6 [A]**.
 - ^{*3}: It is a voltage that can provide constant direct current, and if a DC voltage drop of the measuring system exceeds this value, direct current cannot be provided.
 - (3) **Automatic measurement is possible by specifying direct current superimposed and the type and size of a ripple factor; this is the world's first instrument to provide this function.**
Ripple factor can be specified by selecting one from among the four parameters of increment current ΔI_L , increment voltage ΔV_L , strength of increment magnetic field ΔH , and increment magnetic flux density ΔB .
 - (4) Toroid sample **does not require troublesome third turns** for direct current superimposed; because alternate current, which is in the form of a sinusoidal wave or a pulse wave, is applied to the sample through a capacitor and direct current is applied to the sample through a choke coil.
 - (5) **IR temperature sensor constantly monitors** the temperature (0 to 250°C) of the sample during the measurement, reducing occurrence of accidental burning of a sample.

■ 1.3 Notes for Handling and Installation

- Operate this instrument in a location with the specified temperature and humidity. Operating this instrument in a location which is outside the operation range, such as a location exposed to direct sunlight or with high humidity, may cause a failure. The following shows the range of temperature-humidity to use this instrument:
 - Indoor usage only
 - Temperature: +5°C to +35°C
 - Humidity: Below the moisture amount of 85% RH (+35°C, no dew condensation)
- Do not put this instrument in a location with excessive moisture or dust. Putting this instrument in a location with excessive moisture or dust may cause an electric shock or fire.
- Do not place anything on this instrument other than stated in this Instruction Manual. Placing an object on this instrument other than stated in the Instruction Manual may damage this instrument.
- Do not place anything near the vent. Placing an object near the vent of this instrument traps heat inside this instrument, and may cause an electric shock, fire, or failure.
- Dropping this instrument could result in bodily injury or property damage due to impact. Before carrying this instrument, remove cables, and firmly hold it with both hands while carrying so that it does not fall.

Chapter 2 before Measuring

- This instrument can apply direct current of up to 30 [A]. **Incorrect handling** results in incorrect measurement results, and in addition **may damage the sample or cause a failure, such as failure of this instrument or the power amplifier**. This chapter describes what should be understood to prevent these problems. **Make sure to read this chapter before carrying out the measurement.**

■ 2.1 Process of Direct Current Superimposed Measurement

- The measurement process of this instrument is explained by reference to Fig. 2-1 Deterioration with age of current flowing in a sample. The horizontal axis represents elapsed time, and the vertical axis represents the magnitude of current.

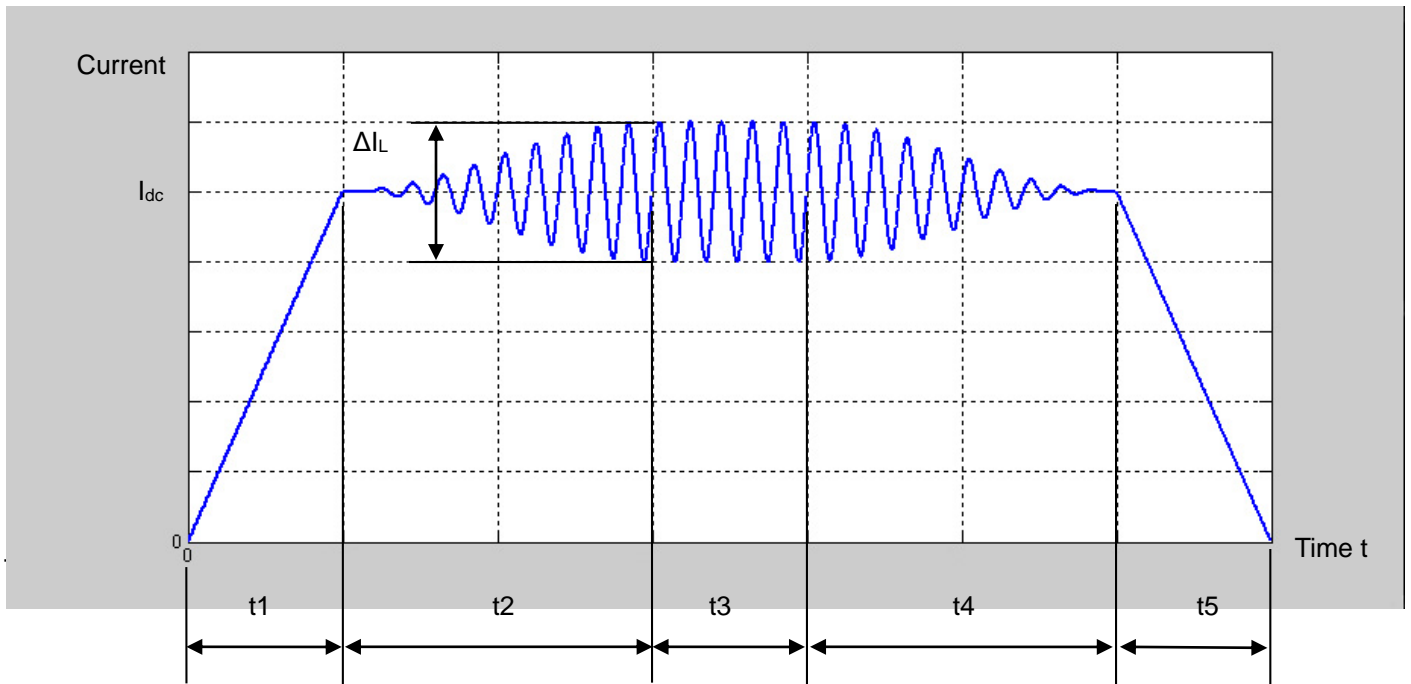

Fig. 2-1 Deterioration with age of current flowing in a sample

- The direct current superimposed measurement of this instrument is carried out through five processes, t1 to t5 in below:
 - (1) Direct current excitation period t1**

First, when the measurement starts, gradually increase direct current over about 2 [s], until it reaches the set value of I_{dc} . It is possible to apply I_{dc} of up to 30 [A].
 - (2) Approximate value excitation period t2**

Next, while maintaining the direct current I_{dc} , gradually increase the ripple current I_L over about 300 [ms] until the specified ripple factor exceeds the set value. It is possible to apply I_L of up to 6 [A] ($\Delta I_L=12$ [A_{p-p}]). For a ripple factor, select one from among the four parameters of increment current ΔI_L , increment voltage ΔV_L , (strength of) increment magnetic field ΔH , and increment magnetic flux density ΔB , and specify the value by **peak-to-peak value**.
 - (3) Asymptote excitation period t3**

Adjust the ripple current I_L slightly by increasing or decreasing to set the specified ripple factor within the range of the set value. When the ripple factor is settled within the set range, fix I_L to carry out the measurement.
 - (4) Alternate current degauss period t4**

Decrease the ripple current I_L gradually over about 300 [ms] after the measurement is completed.
 - (5) Direct current degauss period t5**

After the ripple current I_L becomes 0, decrease direct current gradually until I_{dc} becomes 0 over about 2 [s] to complete the measurement operation.

2.2 Explanation of Operation of Direct Current Superimposed Measurement Circuit

- This section explains the outline of the operation of direct current superimposed measurement circuit of this instrument.

Figure 2-2 and Fig. 2-3 are circuit diagrams of the measuring system when B-H ANALYZER, the power amplifier, and this instrument are combined. Fig. 2-2 illustrates measurement with the 1-coil method, and Fig. 2-3 illustrates measurement with the 2-coil method.

The 1-coil method is a measuring method used to measure a sample, such as an inductor, having only primary turns, whereas the 2-coil method is a measuring method used to measure a sample, such as a transformer, having secondary turns as well as primary turns.

Core loss obtained by the 1-coil method includes copper loss by ESR (equivalent series resistance) of the sample, etc.

The following briefly explains the operation of direct current superimposed measurement of this instrument using the circuit diagram of 1-coil method in Fig. 2-2. The sample is represented in the equivalent circuit of the series connection of ESR R_L and inductance L shown in the center.

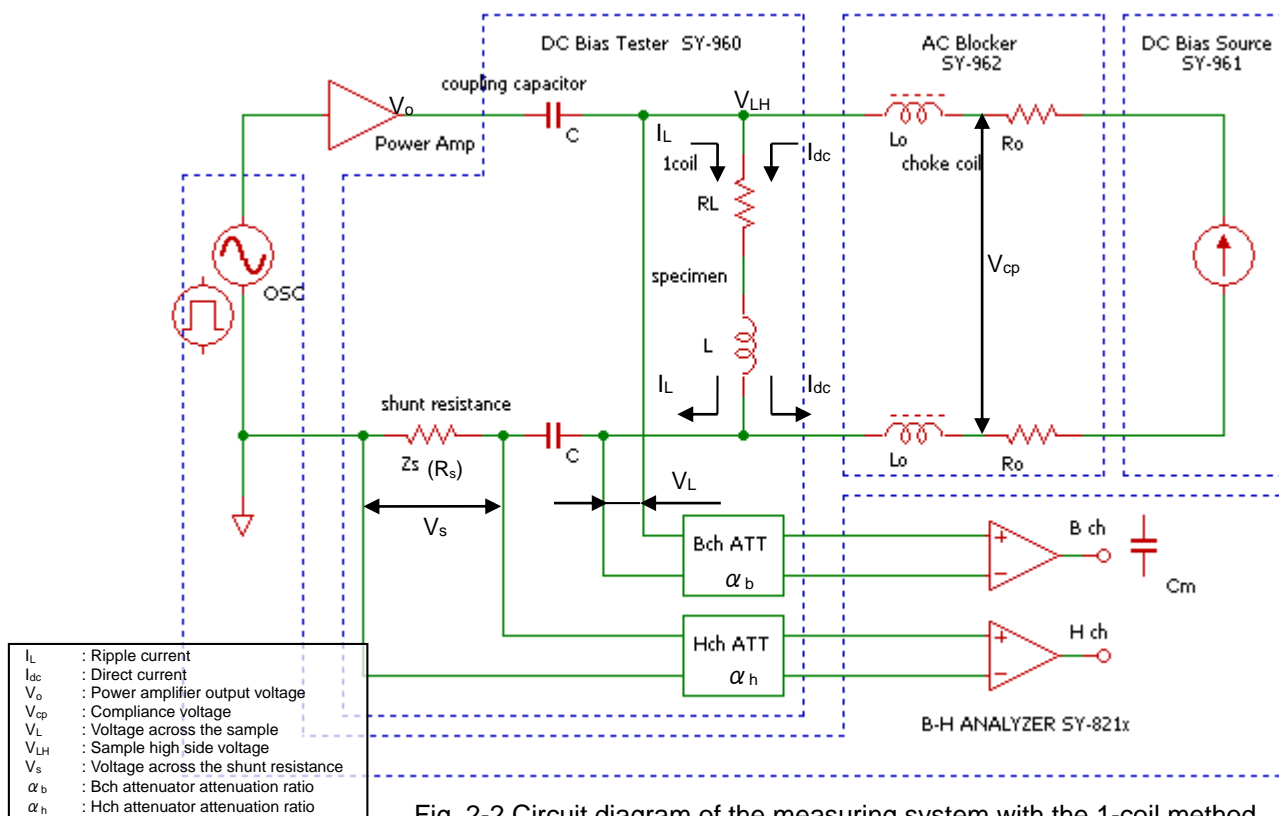

Fig. 2-2 Circuit diagram of the measuring system with the 1-coil method

The direct current I_{dc} set from DC Bias Source SY-961 is applied to the sample through the choke coil (inductance $L_o \approx 0.84$ [mH], resistance $R_o \approx 75$ [m Ω]) of AC Blocker SY-962. The choke coil functions to prevent the ripple current I_L from the power amplifier from flowing into the DC Bias Source.

Next, a sinusoidal wave or a pulse wave of frequency f [Hz] is output from a signal generator OSC which is built into B-H ANALYZER. After being amplified by the power amplifier, the wave current is superimposed with the direct current I_{dc} already flowing and applied to the sample as the ripple current I_L through a coupling capacitor (capacitance $C \approx 550$ [μ F]) of DC Bias Tester SY-960. The coupling capacitor functions to prevent the direct current I_{dc} from the DC Bias Source from flowing into the power amplifier and shunt resistance (impedance $|Z_s| \approx 1$ [Ω]).

At this time, the voltage across the sample V_L is detected by a differential amplifier through the Bch attenuator ATT (attenuation ratio $\alpha_b = 1/4$).

For the 1-coil method, since V_L includes the direct current voltage drop, V_L is calculated and displayed after it is excluded. In contrast, for the 2-coil method, V_L is displayed as it is, because only alternate current is included in the V_L . In addition, with the 2-coil method, V_L is the voltage across the secondary turns. Therefore, the voltage applied across the primary turns of the sample is $(N_1/N_2) V_L$ if the number of primary turns N_1 is not the same as the number of secondary turns N_2 .

Detecting the voltage across the shunt resistance V_s with the differential amplifier through the Hch attenuator ATT (attenuation ratio $\alpha_h=1/4$), the ripple current I_L flowing in the sample is calculated by formula (2.1) with the impedance of the shunt resistance $|Z_s|$. Direct current I_{dc} will not flow in the shunt resistance, thanks to the coupling capacitor.

$$I_L = \frac{V_s}{|Z_s|} \quad (2.1)$$

Measurement is carried out where the value of the specified ripple factor (one from among the four parameters of increment current ΔI_L , increment voltage ΔV_L , strength of increment magnetic field ΔH , and increment magnetic flux density ΔB) becomes the tolerance of the set value. This instrument sets or displays **the value of the ripple factor with peak-to-peak value, rather than with amplitude.**

The strength of magnetic field H is calculated by formula (2.2) with I_L , and the magnetic flux density B is calculated by formula (2.3) with V_L .

$$H(t) = \frac{N_1 I_L(t)}{L_e} \quad (L_e: \text{Effective length of magnetic path of the sample, } N_1: \text{Number of primary turns}) \quad (2.2)$$

$$B(t) = \frac{1}{N_2 A_e} \int_0^t V_L(\tau) d\tau \quad (A_e: \text{Effective net core area of the sample, } N_2: \text{Number of secondary turns}) \quad (2.3)$$

After the measurement is completed, sequentially make the ripple current I_L and the direct current I_{dc} "0" to end the measurement.

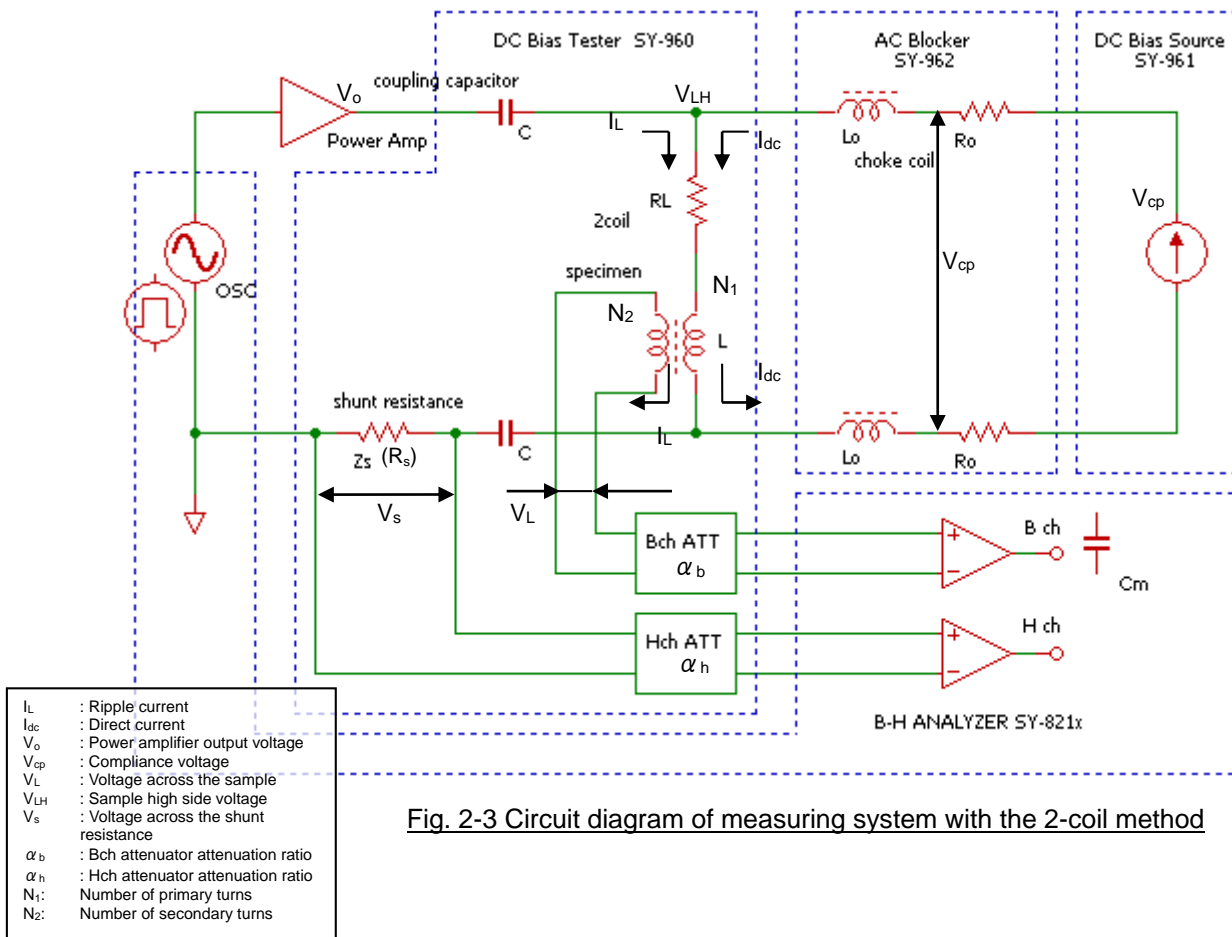

Fig. 2-3 Circuit diagram of measuring system with the 2-coil method

■ 2.3 What must be Calculated and Checked before Starting Measurement

- An outline of the measurement operation of this instrument was explained in the previous sections. This section explains **the necessity of calculation and checking before starting the measurement**. Note that failure to perform these may damage your important sample or cause a failure of this instrument, as well as failing to obtain a correct measurement result.

Not all samples (inductance L, ESR R_L) **can be measured with the measuring frequency, the maximum increment current, the maximum increment voltage, or the maximum direct current superimposed, which are specifications of this instrument.** It depends on the sample.

(1) Impedance Z_L of the sample suitable for measurement

What needs to be understood before measuring with this instrument is that, although it depends on the measuring frequency f , if **impedance Z_L of the sample is large**, some of the ripple current I_L provided from the power amplifier flows into DC Bias Source SY-961 through the choke coil of AC Blocker SY-962, **which causes a measurement error**.

Always check the error before starting the measurement. Note that (2) to (7) assume that no measurement error exists.

The impedance Z_L of the sample is represented as below if a floating capacity can be ignored:

$$Z_L = \sqrt{R_L^2 + (2\pi f L)^2} \quad (2.4)$$

Meanwhile, the impedance Z_0 of AC Blocker SY-962 and DC Bias Source SY-961 looking from the power amplifier is obtained from the following:

$$Z_0 = \sqrt{0.0225 + \left(3.36\pi \times 10^{-3} f - \frac{1}{4.4 \times 10^{-2} \pi f}\right)^2} \quad (2.5)$$

At this time, if the current I_L supplied from the power amplifier is 100%, a ratio η [%] of the error ripple current flowing to the DC Bias Source is obtained from the following formula:

$$\eta = 100 \frac{Z_L}{Z_L + Z_0} \quad (2.6)$$

[Example] $\eta=5.6$ [%] when $L=100$ [μH], $R_L=0.5$ [Ω], and $f=10$ [kHz]

Figure 2-4 shows the leading ratio η against the measuring frequency f and the impedance Z_L of the sample. If a high impedance sample is measured with low measuring frequency, the ratio η of the error ripple current becomes high.

The recommended inductance L of the sample measured with this instrument is **0.1 [μH] to dozens of [μH]**, supposing ESR can be ignored.

- * Contact us when measuring a sample having inductance L that exceeds the recommended value. The compliance voltage described in (4) will drop; however, adding AC Blocker SY-962 **may reduce the error ripple current**.

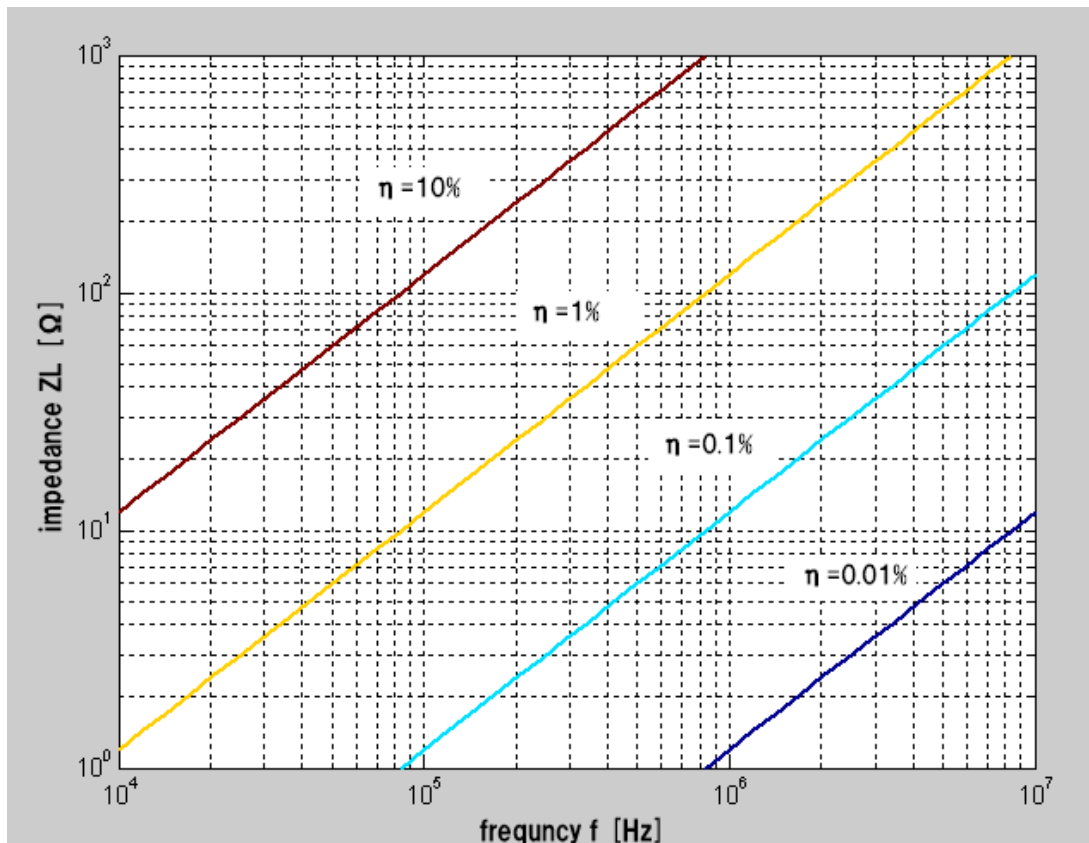

Fig. 2-4 Error ripple current ratio η

(2) Resonance frequency f_{c1} of RLC series circuit

Looking from the power amplifier, the measuring circuit of this instrument is an RLC series circuit. **Measure with a measuring frequency f which is at least ten times the resonance frequency f_{c1} of this circuit.**

In this case, the resistance R is equivalent to the sum of ESR R_L and the direct current resistance R_s (about 1 [Ω]) of the shunt resistance of the sample, the inductance L is equivalent to the primary turns inductance L of the sample, and the capacitance C is equivalent to the sum of two coupling capacitors C (about 550 [μF]) connected in series. In this section, because the parasitic inductance of the shunt resistance is a few [nH], which is considerably smaller compared with the inductance of the sample, the parasitic inductance is ignored unless otherwise stated.

Thus, the resonance frequency f_{c1} [Hz] in this series circuit is:

$$f_{c1} = \frac{1}{2\pi\sqrt{\frac{LC}{2}}} = \frac{1}{2\pi\sqrt{275 \times 10^{-6}L}} \quad (2.7)$$

With this resonance frequency, the impedance of the measuring system, including the sample looking from the power amplifier, is minimal.

It is very dangerous to carry out measurement close to this frequency because, depending on the specified ripple factor, **current that exceeds the expected value flows, potentially damaging the sample, or exceeds the rated output current of the power amplifier, which could cause an amplifier failure.** Make sure to measure with the measuring frequency f that is at least ten times the resonance frequency f_{c1} .

$$f \geq 10f_{c1} \quad (2.8)$$

[Example] $f_{c1}=3.04$ [kHz] and $f \geq 30.4$ [kHz] when $L=10$ [μH]

This instrument can measure **up to 6 [A] of ripple current I_L** . The shunt resistance will be burnt and fail if current that exceeds the above value flows. Check the specification of your power amplifier for the rated output current of the power amplifier.

(3) Resonance frequency f_{c2} of the LC parallel circuit using the 2-coil method

For using this instrument **with the 2-coil method**, use a measuring frequency f of **one-tenth or less of the resonance frequency f_{c2}** of this circuit, because when looking from the power amplifier, the measuring circuit for the voltage across sample V_L is an LC parallel circuit.

In this case, the inductance L is equivalent to the primary turns inductance L of the sample, and the capacitance C is equivalent to the input capacitance C_m (about 25.5[pF]) of the measuring circuit for the voltage across the sample V_L .

Thus, the resonance frequency f_{c2} [Hz] in this parallel circuit is:

$$f_{c2} = \frac{1}{2\pi\sqrt{LC_m}} = \frac{1}{2\pi\sqrt{25.5 \times 10^{-12}L}} \quad (2.9)$$

With this resonance frequency, the impedance of the measuring system, including the sample looking from the power amplifier, is maximized.

It is very dangerous to carry out measurement close to this frequency because, depending on the specified ripple factor, **voltage that exceeds the expected value is applied to both ends of the sample, potentially damaging the sample, or exceeds the rated output voltage of the power amplifier, which could cause an amplifier failure.** Make sure to measure with a measuring frequency f that is one-tenth or less of the resonance frequency f_{c2} .

$$f \leq \frac{1}{10} f_{c2} \quad (2.10)$$

[Example] $f_{c2}=9.97$ [MHz] and $f \leq 997$ [kHz] when $L=10$ [μ H]

The maximum voltage across the sample V_L that can be measured with the 2-coil method is 200 [V]. Measuring a voltage that exceeds the maximum voltage will damage the V_L measuring circuit. Check the specification of your power amplifier for the rated output voltage of the power amplifier.

(4) Compliance voltage V_{cp}

Carry out the measurement under the conditions where the compliance voltage does not exceed the maximum compliance voltage 10 [V] of the DC Bias Source.

The compliance voltage V_{cp} [V] of the DC Bias Source when the direct current I_{dc} flows in the sample (ESR R_L) is:

$$V_{cp} = I_{dc}(R_L + 2R_0) = I_{dc}(R_L + 2 \times 0.083) \quad (2.11)$$

The term $2 R_0$ represents a voltage drop across the AC Blocker. **If this V_{cp} exceeds 10 [V],** the DC Bias Source turns the output OFF and the B-H ANALYZER forcibly terminates the measurement, because the **DC Bias Source cannot provide direct current.**

[Example] $V_{cp}=8.5$ [V] when $R_L=0.4$ [Ω] and $I_{dc}=15$ [A].

(5) Sample high side voltage V_{LH} with the 1-coil method

When using this instrument **by specifying increment current ΔI_L with the 1-coil method,** carry out the measurement **under the conditions where the sample high side voltage V_{LH} does not exceed 200 [V].**

The sample high side voltage V_{LH} [V] when the direct current I_{dc} and increment current ΔI_L of the frequency f flows in the sample (the inductance L , ESR R_L) is:

$$\begin{aligned} V_{LH} &= \frac{\Delta I_L}{2} \sqrt{(R_L + R_s)^2 + \left(2\pi f L - \frac{1}{2\pi f C}\right)^2} + I_{dc} \left(R_L + \frac{2.25}{30}\right) \\ &= \frac{\Delta I_L}{2} \sqrt{(R_L + 1)^2 + \left(2\pi f L - \frac{1}{2\pi f \times 550 \times 10^{-6}}\right)^2} + I_{dc} \left(R_L + \frac{2.25}{30}\right) \end{aligned} \quad (2.12)$$

It is very dangerous to carry out the measurement under measurement conditions where V_{LH} exceeds 200 [V], because **V_{LH} actually exceeds 200 [V], potentially damaging the V_L measuring circuit, or exceeds the rated output voltage of the power amplifier, which could damage the amplifier.**

[Example] $V_{LH}=160.0[V]$ when $L=10 [\mu H]$, $R_L=0.5 [\Omega]$, $I_{dc}=5 [A]$, $f=1 [MHz]$, and $\Delta I_L=5 [A_{p-p}]$.

The maximum sample high side voltage V_{LH} that can be measured with the 1-coil method is 200 [V]. Applying a voltage that exceeds the maximum voltage will damage the V_L measuring circuit. Check the specification of your power amplifier for the rated output voltage of the power amplifier.

(6) Voltage across the sample V_L with the 2-coil method and the voltage across the primary turns

When using this instrument **by specifying increment current ΔI_L with the 2-coil method**, carry out the measurement **under the conditions where the voltage across the sample V_L does not exceed 200 [V].**

The voltage across the sample V_L when the increment current ΔI_L of the frequency f flows in the sample (primary turns inductance L) is:

$$V_L = \frac{\Delta I_L}{2} 2\pi f L = \pi f L \Delta I_L \quad (2.13)$$

It is very dangerous to carry out measurement under the measurement conditions where V_L exceeds 200 [V], because **V_L actually exceeds 200 [V], which could damage the V_L measuring circuit, or exceeds the rated output voltage of the power amplifier, which could damage the amplifier.**

Extra care must be taken when the number of primary turns (N_1) is greater than that of secondary turns (N_2), because the voltage across the primary turns becomes N_1/N_2 times V_L .

[Example] $V_L=157.1 [V]$ and the voltage across the primary turns=314.2 [V] when $N_1=40$, $N_2=20$, $L=10 [\mu H]$, $f=1 [MHz]$, and $\Delta I_L=5 [A_{p-p}]$

The maximum voltage across the sample V_L that can be measured with the 2-coil method is 200 [V]. Applying a voltage that exceeds the maximum voltage will damage the V_L measuring circuit. Check the specification of your power amplifier for the rated output voltage of the power amplifier.

(7) Frequency f_{tri} in which ripple current I_L is in the form of a triangular wave

When using this instrument with a pulse wave output, a reactance by the inductance L of the sample of the measuring system looking from the power amplifier **must be larger than the resistance that includes ESR R_L of the sample to make ripple current I_L a triangular wave.**

Thus, the frequency f_{tri} [Hz] which makes the reactance equal to the resistance is:

$$f_{tri} = \frac{R_L + R_s}{2\pi L} = \frac{R_L + 1}{2\pi L} \quad (2.14)$$

and ripple current I_L cannot make a triangular wave unless it is measured with a frequency f which is higher than neighborhood of this frequency.

[Example] $f_{tri}=238.7 [kHz]$ when $L=1 [\mu H]$ and $R_L=0.2 [\Omega]$.

Although it depends on the amplitude frequency bandwidth properties of the power amplifier, generally, **the output from the power amplifier cannot make a pulse wave unless it is below 1/10 the upper limit of the frequency bandwidth.** Check the specification of your power amplifier.

2.4 Expressions to Calculate Measurement Values

- The following is an explanation of expressions to calculate values measured by this instrument.

This instrument uses two measuring modes of **Normal mode** and **μ mode**, and Table 2-1 shows measurement values displayed in each calculation mode.

The point of difference between calculation of Normal mode and calculation of μ mode is the following. In μ mode, the complex permeability from the fundamental wave element of the magnetic field H and magnetic flux density B is calculated. In Normal mode, a value which is not calculated by using them is calculated. Refer to the following expressions for details.

Table 2-1 Calculation modes and measurement values

* Units in [] are typical. A symbol denoted with * is calculated from the fundamental wave element.

Calculation modes	Normal mode			μ mode		
	Symbol	Typical unit	Meaning	Symbol	Typical unit	Meaning
Measurement values	ΔPcv	[W/m ³]	Increment core loss per volume	ΔB	[T]	Increment magnetic flux density
	ΔPcm	[W/kg]	Increment core loss per weight	ΔVL	[V]	Increment voltage
	θ	[deg]	Phase angle	ΔH	[A/m]	(Strength of) increment magnetic field
	μ _Δ	—	Increment permeability	ΔIL	[A]	Increment current
	ΔB	[T]	Increment magnetic flux density	μ _Δ	—	Increment permeability
	ΔVL	[V]	Increment voltage	H _{dc}	[A/m]	DC bias magnetic field
	ΔH	[A/m]	(Strength of) increment magnetic field	*L	[H]	Inductance
	ΔIL	[A]	Increment current	*R	[Ω]	Resistance
	H _{dc}	[A/m]	DC bias magnetic field	* Z	[Ω]	Impedance
	ΔPc	[W]	Increment core loss	ΔPc	[W]	Increment core loss
	ΔVA	[VA]	Increment apparent power	*μ'	—	Complex permeability (real part)
	—	—	—	*μ"	—	Complex permeability (imaginary part)
	—	—	—	*μ _z	—	Impedance permeability
	—	—	—	*tanδ	—	Loss coefficient
	—	—	—	*θ	[deg]	Phase angle
—	—	—	THD	[dB]	Total harmonic distortion	

$$\Delta V_L = |V_{Lm \uparrow}| + |V_{Lm \downarrow}| \quad (2.15)$$

($V_{Lm \uparrow}$: maximum value of $V_L(t)$, $V_{Lm \downarrow}$: minimum value of $V_L(t)$)

$$\Delta I_L = |I_{Lm \uparrow}| + |I_{Lm \downarrow}| \quad (2.16)$$

($I_{Lm \uparrow}$: maximum value of $I_L(t)$, $I_{Lm \downarrow}$: minimum value of $I_L(t)$)

$$\Delta B = |B_{m \uparrow}| + |B_{m \downarrow}| \quad (2.17)$$

($B_{m \uparrow}$: maximum value of $B(t)$, $B_{m \downarrow}$: minimum value of $B(t)$)

$$\Delta H = |H_{m \uparrow}| + |H_{m \downarrow}| \quad (2.18)$$

($H_{m \uparrow}$: maximum value of $H(t)$, $H_{m \downarrow}$: minimum value of $H(t)$)

$$\mu \Delta = \frac{\Delta B}{\mu_0 \Delta H} \quad (2.19)$$

(μ_0 : Vacuum permeability $4\pi \times 10^{-7}$ [H/m])

$$H_{dc} = \frac{N_1}{L_e} I_{dc} \quad (2.20)$$

(N_1 : Number of primary turns, L_e : Effective length of magnetic path)

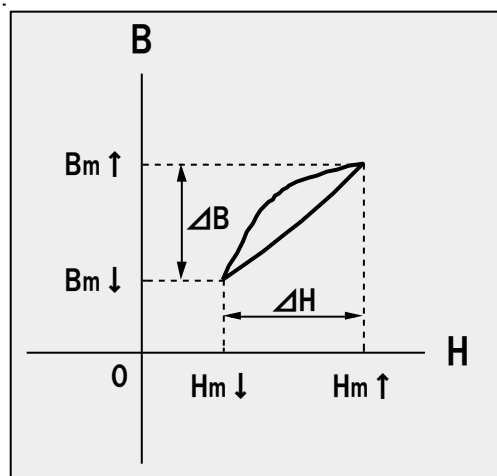

Fig. 2-5 ΔB and ΔH

$$\Delta P_c = \frac{N_1}{N_2} \frac{1}{T} \int_0^T I_L(t) V_L(t) dt \quad (2.21)$$

(N₂: Number of secondary turns, T: Measuring period)

* N₂=N₁ when the 1-coil method is selected

$$\Delta VA = \frac{N_1}{N_2} I_{L\text{RMS}} V_{L\text{RMS}} \quad (2.22)$$

(I_{L,RMS}: Effective value of I_L(t), V_{L,RMS}: Effective value of V_L(t))

* N₂=N₁ when the 1-coil method is selected

$$\Delta P_{cv} = \frac{\Delta P_c}{V_e} \quad (2.23)$$

(V_e: Effective volume)

$$\Delta P_{cm} = \frac{\Delta P_c}{W_e} \quad (2.24)$$

(W_e: Weight)

Normal mode $\theta = \cos^{-1} \left(\frac{\Delta P_c}{\Delta VA} \right) \quad (2.25)$

* For θ of μ mode, calculate with formula (2.28)

$$\mu' - j \mu'' = \frac{B(\omega_0)}{\mu_0 H(\omega_0)} \quad (2.26)$$

(j: Imaginary unit, ω₀: Base angular frequency)

$$\mu_z = \sqrt{(\mu')^2 + (\mu'')^2} \quad (2.27)$$

μ mode $\theta = \cos^{-1} \left\{ \frac{\Delta P_c(\omega_0)}{\Delta VA(\omega_0)} \right\} \quad (2.28)$

$$\tan \delta = \frac{\mu''}{\mu'} \quad (2.29)$$

$$L = \frac{\mu' \mu_0 A_e N_1^2}{L_e} \quad (2.30)$$

$$R = \frac{\omega_0 \mu'' \mu_0 A_e N_1^2}{L_e} \quad (2.31)$$

$$|Z| = \sqrt{R^2 + (\omega_0 L)^2} \quad (2.32)$$

$$\text{THD} = 20 \log_{10} \frac{\sqrt{V_L^2(3\omega_0) + V_L^2(5\omega_0) + V_L^2(7\omega_0)}}{V_L(\omega_0)} \quad (2.33)$$

Chapter 3 Name and Function of Each Part of Each Instrument

■ 3.1 SY-960 DC Bias Tester Front Panel

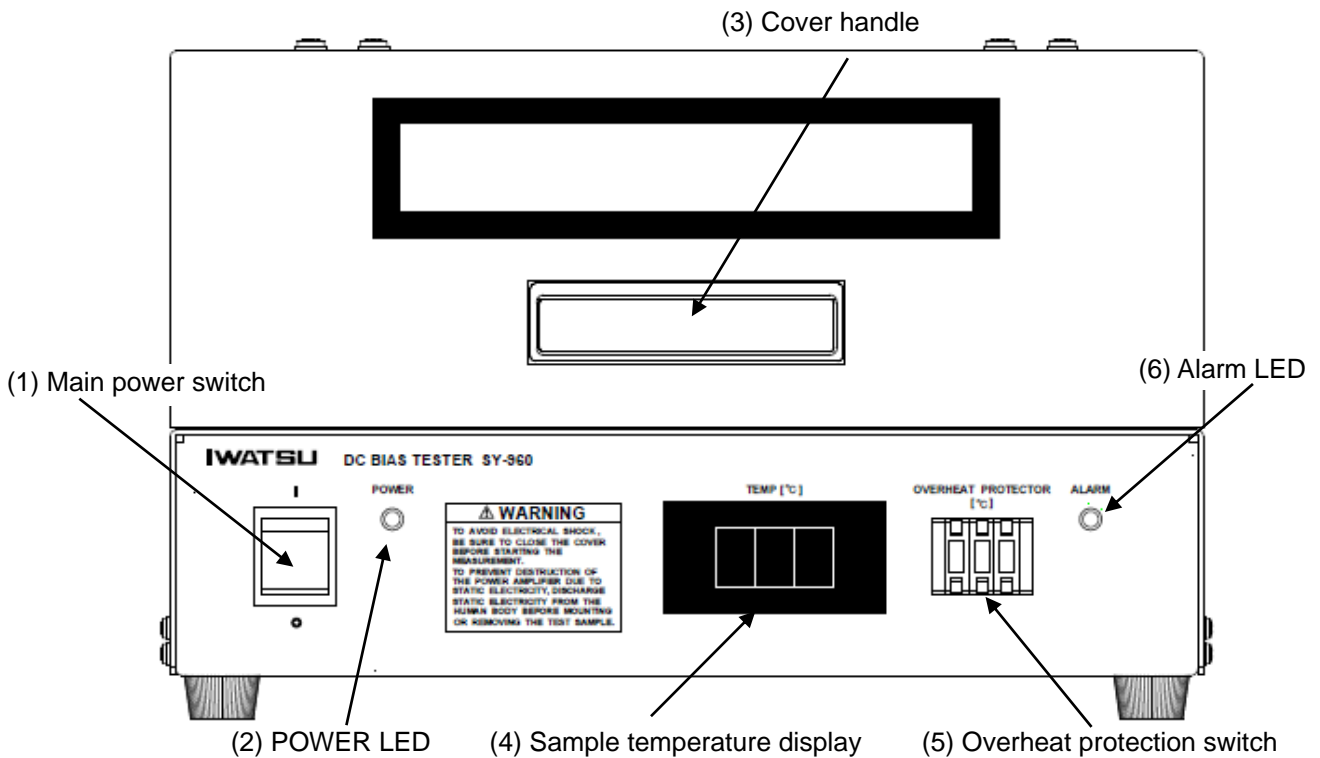

Fig. 3-1 Front panel of SY-960

- (1) **Main power switch**
Main power source switch of DC Bias Tester SY-960.
- (2) **POWER LED**
Lights a lamp when the power source is turned ON.
- (3) **Cover handle**
Use this handle for opening / closing the cover. When closing the cover, make sure that it is firmly pushed until it makes a clicking noise. It cannot perform a measurement while the cover is open.
- (4) **Sample temperature display**
Displays the highest temperature among temperatures sensed by each IR sensor for sample temperature installed at two locations.
- (5) **Overheat protection switch**
When a temperature sensed by the IR sensor for measuring sample temperature exceeds the temperature [°C] set with this switch, the sample temperature display blinks and the measurement is forcibly terminated. The range of temperatures that can be set with this switch is 0 to 250 [°C].

* Any temperature set to over 250 [°C] is set as 250 [°C].
- (6) **Alarm LED**
Lights a lamp when an error occurs. B-H ANALYZER displays the contents of the error, and if the error occurs during the measurement, the measurement is forcibly terminated.
* Turning the main power switch ON turns the LED ON for a moment; however, it does not continuously turn ON, and is not an error.

■ 3.2 SY-960 DC Bias Tester Top Panel (No Cover)

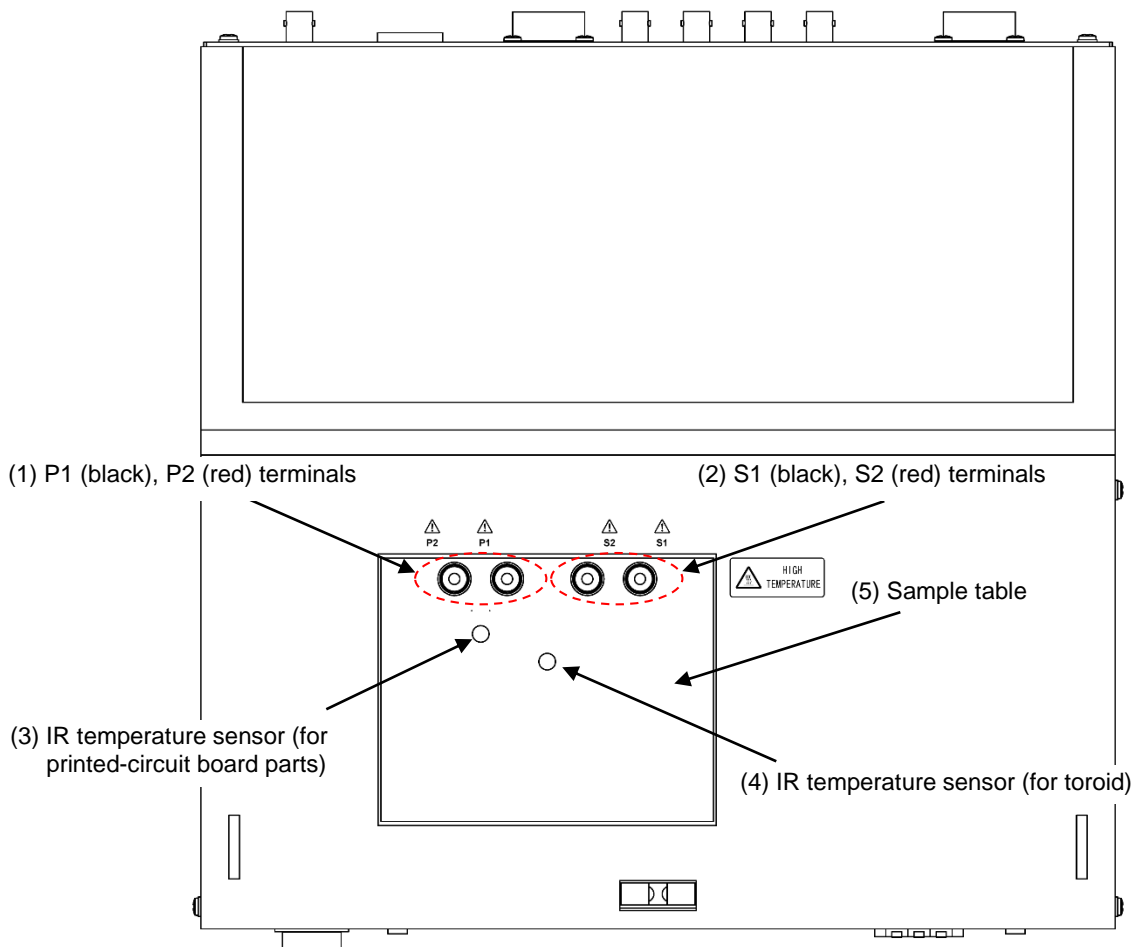

Fig. 3-2 Top part of SY-960 (no cover)

(1) P1, P2 terminals

Connect primary turns terminal of the sample. It is made from polyamide (PA) resin.

* PA resin may change its shape if the temperature exceeds 80°C.

(2) S1, S2 terminals

Connect the secondary turns terminal of the sample. It is made from polyamide (PA) resin.

* PA resin may change its shape if the temperature exceeds 80°C.

(3) IR temperature sensor (for printed-circuit board parts)

This IR temperature sensor senses the temperature of the back of the parts mounted on a dedicated printed-circuit board of SY-960.

* Do not use a printed-circuit board other than a dedicated printed-circuit board which is an accessory of SY-960.

(4) IR temperature sensor (for toroid)

This IR temperature sensor senses the temperature of a toroid sample. To measure the toroid sample, mount the part to be measured on the sensor.

* The polyethylene sheet to protect the sensor is fragile. Do not use any items other than the blower brush which is an accessory of SY-960 to clean the sheet.

(5) Sample table

Area to mount the sample. It is made from polyether ether ketone (PEEK) resin.

* PEEK resin may change its shape if the temperature exceeds 250°C

3.3 SY-960 DC Bias Tester Rear Panel

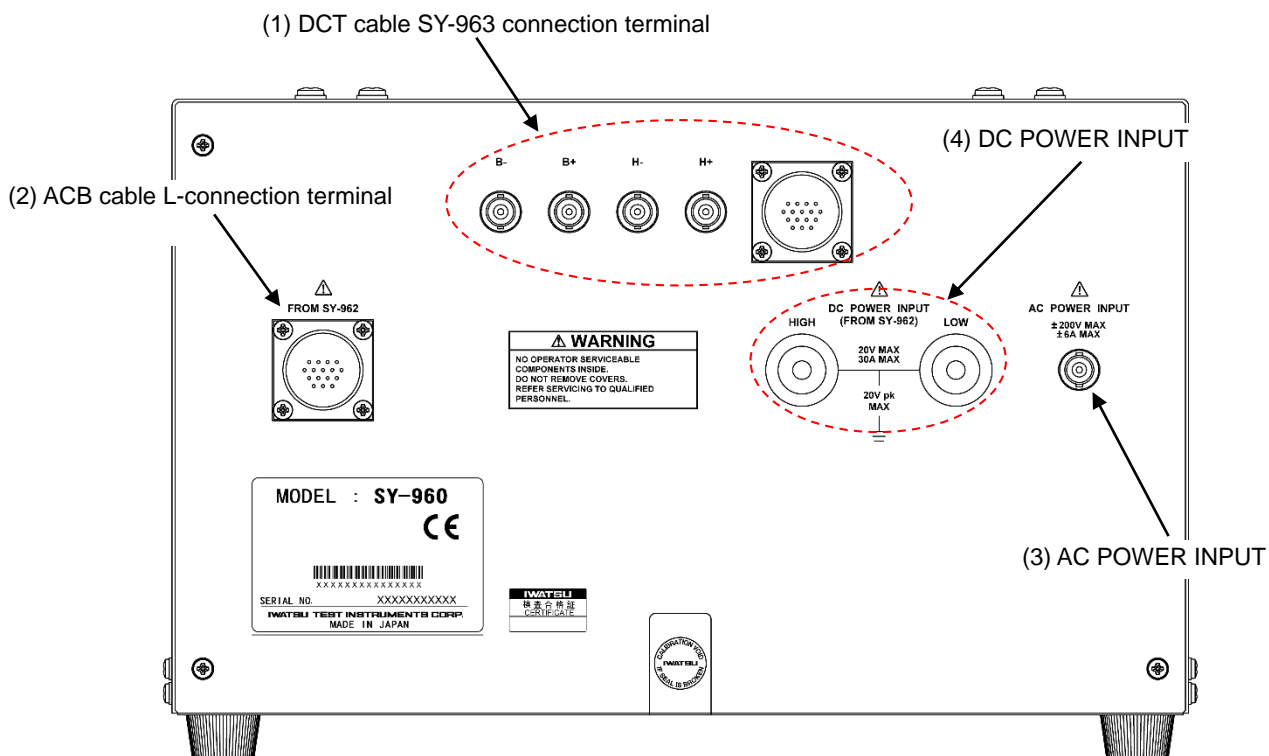

Fig. 3-3 Rear panel of SY-960

- (1) **DCT cable SY-963 connection terminal**
Connects to B-H ANALYZER using a DCT cable SY-963, which is an accessory of SY-960.
- (2) **ACB cable L-connection terminal**
Connects to AC Blocker SY-962 using an ACB cable L, which is an accessory of SY-962.
- (3) **AC POWER INPUT**
Connects output from the power amplifier using a BNC cable.
- (4) **DC POWER INPUT**
It is an input terminal of DC for direct current superimposed. It connects to AC Blocker SY-962 using a DC cable L, which is an accessory of SY-962. Red and black cables connect to red and black terminals respectively.

3.4 SY-961 DC Bias Source Front Panel

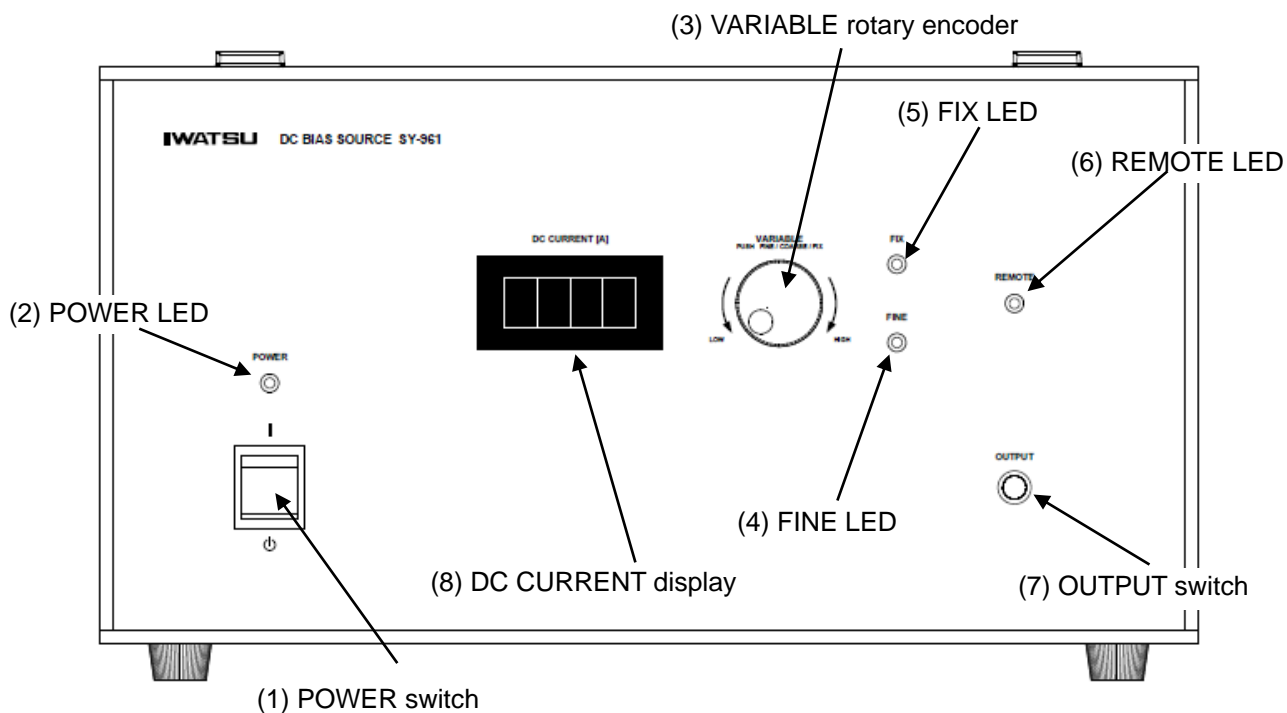

Fig. 3-4 Front panel of SY-961

(1) POWER switch

It is a switch to start / end DC Bias Source SY-961.

* This switch will not be enabled unless the main power switch in the rear is turned ON.

(2) POWER LED

Lights a lamp when the power source is turned ON.

(3) VARIABLE rotary encoder

Sets the output current. The setting range is from 0.00 to 30.00 [A]. Each time it is pushed, it provides a different function. Table 3-1 lists the functions.

Table 3-1 Functions of VARIABLE rotary encoder

Number of pushes	States	Lighting LED		Functions
		FINE	FIX	
Immediately after the POWER is ON	FINE	○	–	Rotating the knob clockwise / counterclockwise increases / decreases the DC output set value by 10 [mA].
Once	COARSE	–	–	Rotating the knob clockwise / counterclockwise increases / decreases the DC output set value by 1 [A].
Twice	FIX	–	○	Fixes the DC output set value. Rotating the knob does not change the value.

Afterward, the above functions are repeated each time the encoder is pushed.

* REMOTE LED of (6) lights a lamp, during which time it does not work and REMOTE is prioritized.

(4) FINE LED

Lights a lamp in the FINE state listed in Table 3-1.

(5) FIX LED

Lights a lamp in the FIX state listed in Table 3-1.

(6) **REMOTE LED**

Lights a lamp in the REMOTE state.

(7) **OUTPUT switch**

Turns output of the set direct current superimposed DC ON/OFF. LED lights when it is ON.

* Only OFF works when REMOTE LED (6) lights and DC Bias Source is in REMOTE state.

(8) **DC CURRENT display**

Normally displays an output value of the set direct current superimposed DC. During an error or Warning, the number of the error or warning flashes. Here, if it is connected to B-H ANALYZER and remotely operated, the applicable message will be displayed on the measurement screen of B-H ANALYZER. Table 3-2 lists errors and Warnings to be displayed.

Table 3-2 Display of DC CURRENT display

SY-961 display	SY-821x display message	Cause	Action
E17	E17: Temp. of FET heat sink on DCS exceeds setting!	Heat sink temperature (thermistor) of FET exceeded the set value (90°C).	Restart SY-961. If the same condition persists, contact our service center and give us the message No.
E18	E18: DCS over current!	The output current of SY-961(DCS) exceeded setting value $\times 1.1$.	Power off SY-961. Contact Iwatsu service center to tell the error message No.
W25	W25: DCS serial communication is abnormal!	Serial communication with DC Bias Tester SY-960 is not normal.	Restart B-H ANALYZER, SY-960, and SY-961.
W55	W55: DCS overvoltage!	Compliance voltage of DC Bias Source is overvoltage.	Check that ESR allows flow of large I_{dc} to a large sample, and then restart SY-961.
W56	W56: DCS no current!	Current is not output from DC Bias Source.	Check whether the DC cable is broken or disconnected, and then restart SY-961.
		DC Bias Source broke down.	Restart SY-961 and measure again. If the same condition persists, contact our service center and give us the message No.
W57	W57: Temp. of FET heat sink on DCS exceeds setting!	Heat sink temperature (IC temperature sensor) of FET exceeded the set value (90°C).	Restart SY-961.
W71	W71: DCS output time out!	The electric current output time of SY-961(DCS) exceeded the time limit.	Try to increase Tolerance.
			Decrease the number of Retry times.

* For display on SY-961, E is displayed as **E** and W is displayed as **!!**.

3.5 SY-961 DC Bias Source Rear Panel

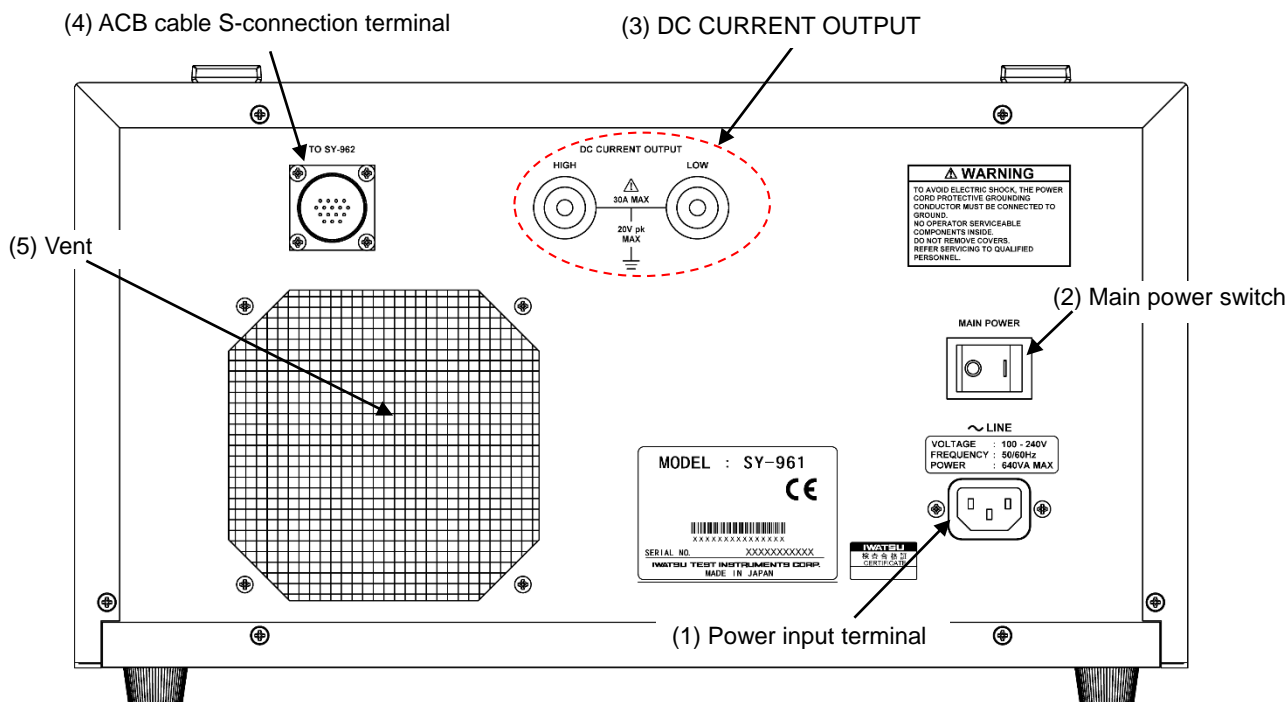

Fig. 3-5 Rear panel of SY-961

- (1) **Power input terminal**
AC power source input. Connect the power source cable, which is an accessory of SY-961.
- (2) **Main power switch**
Turns the main power source of DC Bias Source SY-961 ON and OFF. The position of I means ON, and the position of O means OFF.
- (3) **DC CURRENT OUTPUT**
An output terminal of direct current superimposed DC. It connects to AC Blocker SY-962 using a DC cable S, which is an accessory of SY-962.
Red and black cables connect to red and black terminals respectively.
- (4) **ACB cable S-connection terminal**
Connects to AC Blocker SY-962 using an ACB cable S, which is an accessory of SY-962.
- (5) **Vent**
A forced air cooling vent of the power source.

■ 3.6 SY-962 AC Blocker Rear Panel

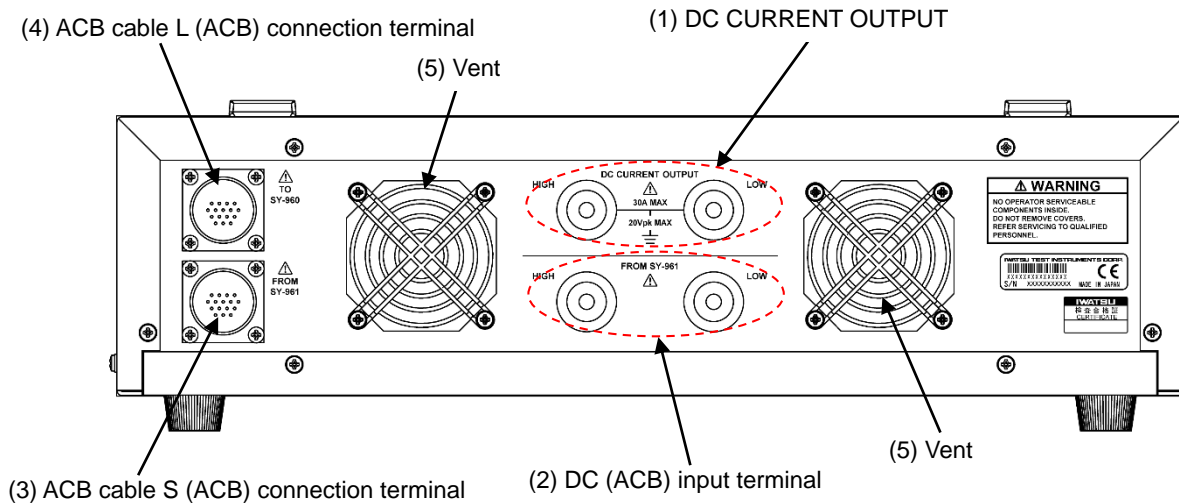

Fig. 3-6 Rear panel of SY-962

(1) DC CURRENT OUTPUT

An output terminal of direct current superimposed DC. It connects to DC Bias Tester SY-960 using a DC cable L, which is an accessory of SY-962. Red and black cables connect to red and black terminals respectively.

(2) DC (ACB) input terminal

A direct current superimposed DC input terminal. It connects to DC Bias Source SY-961 using a DC cable S, which is an accessory of SY-962. Red and black cables connect to red and black terminals respectively.

(3) ACB cable S (ACB) connection terminal

Connects to DC Bias Source SY-961 using an ACB cable S which is an accessory of SY-962.

(4) ACB cable L (ACB) connection terminal

Connects to DC Bias Tester SY-960 using an ACB cable L, which is an accessory of SY-962.

(5) Vent

A forced cooling vent for the choke coil.

Chapter 4 Measurements

4.1 Flow of Measurement

The following flow chart shows measurement procedures using SY-960 / 961 / 962.

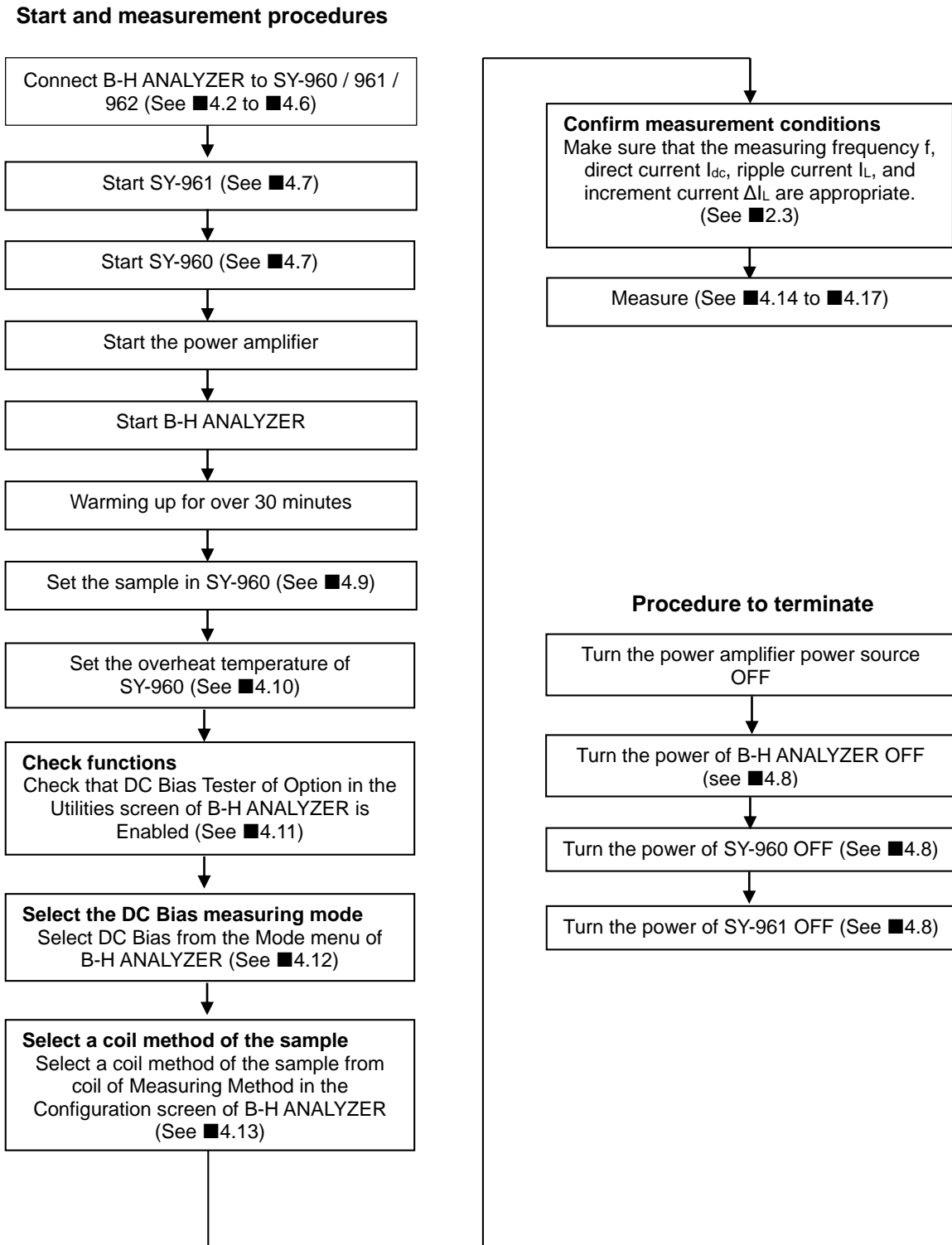

Fig. 4-1 Flow of measurement

■ 4.2 Jointing SY-961 and SY-962

- This section explains the joint procedures of DC Bias Source SY-961 and AC Blocker SY-962 using Fig. 4-2.
- * Make sure to carry out jointing to use. This work grounds the case of SY-962. It also prevents SY-962 from falling from SY-961.
- * Do not carry SY-961 and SY-962 in a state where they are jointed. Doing so may result in bodily harm or property damage.

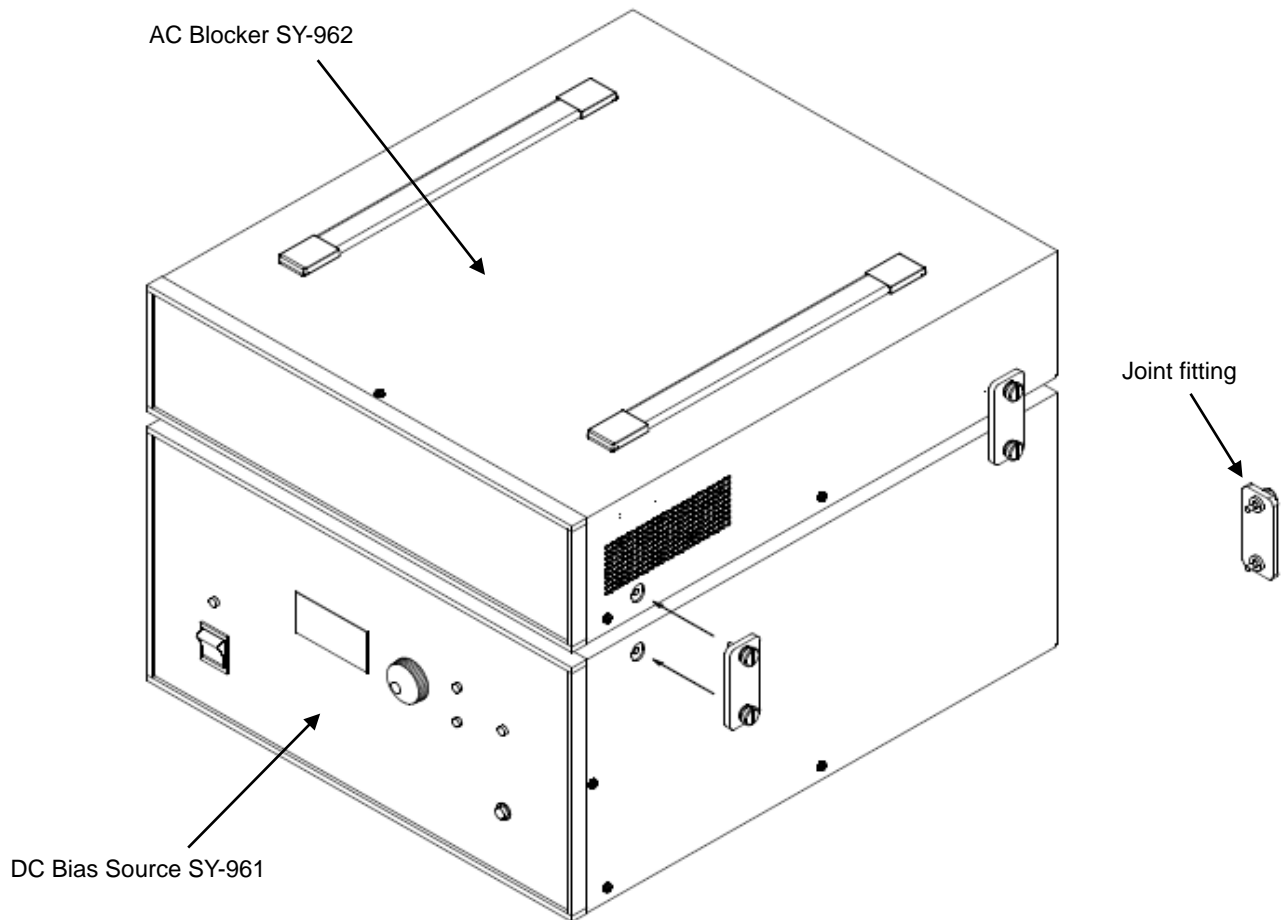

Fig. 4-2 Jointing SY-961 and SY-962

- (1) Gently place DC Bias Source SY-961 on a flat surface.
- (2) Gently place AC Blocker SY-962 on SY-961. When doing so, match the orientations of the front and rear panels.
- (3) Fix SY-962 and SY-961 on the sides at four places using four joint fittings that are accessories of SY-962. Insert the projections of joint fittings into the holes of the covers.
Note that if the positions of SY-961 and SY-962 are shifted, joint fittings may fail to be inserted appropriately. Once a joint fitting is inserted, rotate a thumbscrew by pinching with your fingers to fix it.

■ 4.3 Connecting Instrument

- Figure 4-3 shows a connection diagram of a measuring instrument in which SY-960 / 961 / 962 are mounted.

See ■4.4 to ■4.6 for details about connecting DCT cable SY-963, DC cable, and ACB cable.

* To use DC Bias Tester SY-960, **always connect B-H ANALYZER that has been adjusted together with DC Bias Tester SY-960 for combination**. Measurement cannot be performed correctly by connecting with B-H ANALYZER which is not adjusted.

* When using IE-1125x, the dedicated power amplifier, always use the dedicated power amplifier cable IE-1125 OSC CABLE SY-911 to connect to B-H ANALYZER. Otherwise, IE-1125x will break down.

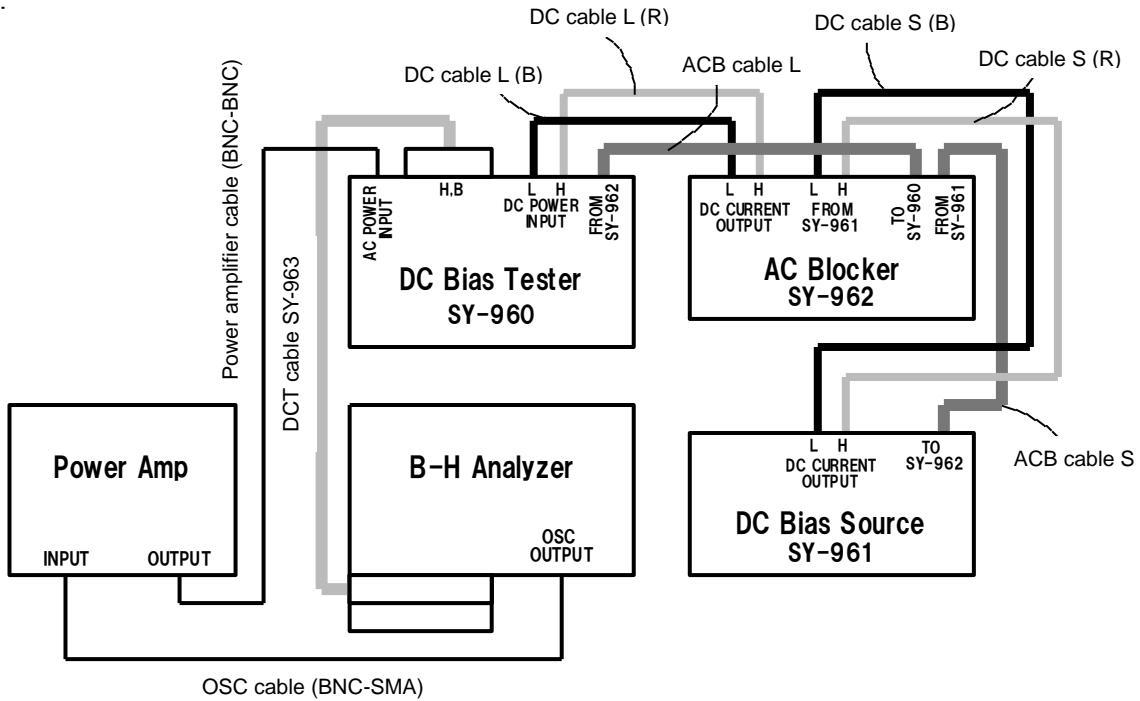

Fig. 4-3 Connecting SY-960 / 961 / 962

■ 4.4 Connecting DCT Cable SY-963

- This section explains connection procedures of DCT cable SY-963, which is an accessory of SY-960.

(1) Make sure that the power sources of B-H ANALYZER and DC Bias Tester SY-960 are **always turned OFF**.

(2) Remove the measurement for terminal block from the measurement POD.

First of all, remove M3 screws at two locations of the terminal block, using a phillips screwdriver. (See Fig. 4-4)

(3) Pinch terminal block knobs with both hands and pull them out vertically. (See Fig. 4-5)

* Do not lose M3 screws, and keep them safely.

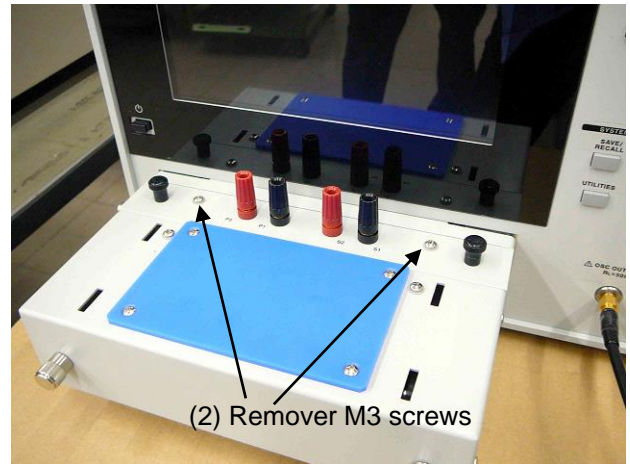

Fig. 4-4 Removing the measurement for terminal block

(4) Mount the measurement for terminal block of DCT cable SY-963.

First of all, align the terminal block guide with the measurement POD guide. (See Fig.4-6 and 4-7)

Next, slowly and vertically pull down the terminal block in accordance with the guidance. (See Fig. 4-7)

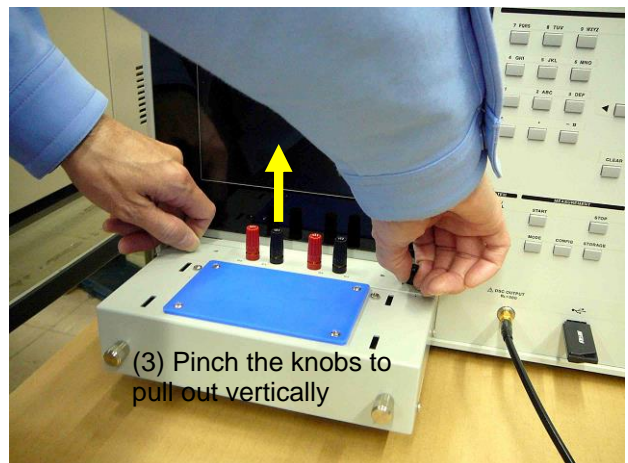

Fig. 4-5 Removing the measurement for terminal block

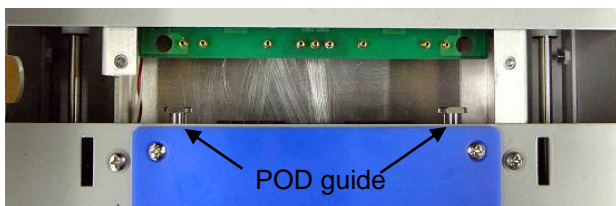

Fig. 4-6 POD guide

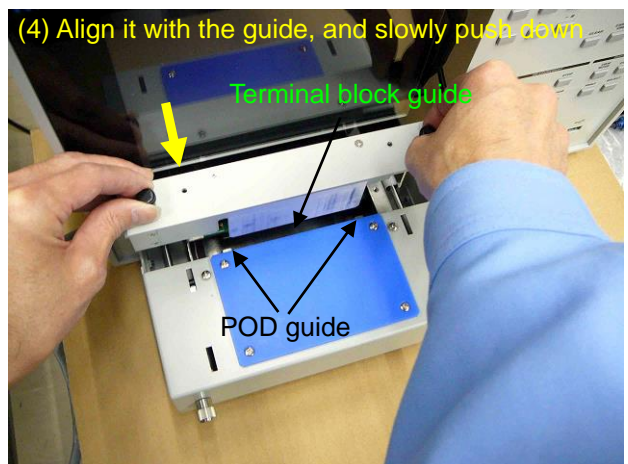

Fig. 4-7 Inserting SY-963 terminal block

- (5) After confirming that the terminal block is securely mounted on the measurement POD, fix the terminal block to the measurement POD using two thumbscrews for the terminal block, which is an accessory of SY-960. (See Fig. 4-8)
- (6) Mount the measurement connector of DCT cable SY-963 on the rear side of DC Bias Tester SY-960. Fit four BNC and a multi pin connector. (See Fig. 4-9)
- (7) Turn the lever clockwise to fix the connector. (See Fig. 4-10)

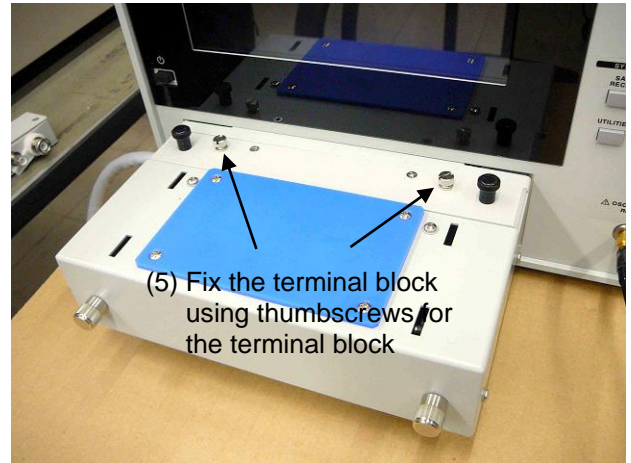

Fig. 4-8 Fixing SY-963 terminal block

- (6) Fit four BNC and a high pin connector

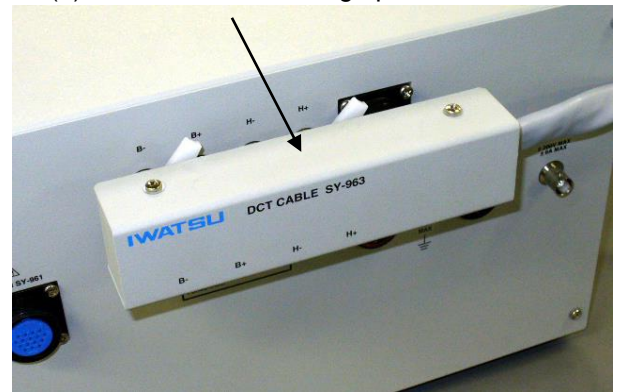

Fig. 4-9 Fitting SY-963

- (7) Turn the lever clockwise to fix

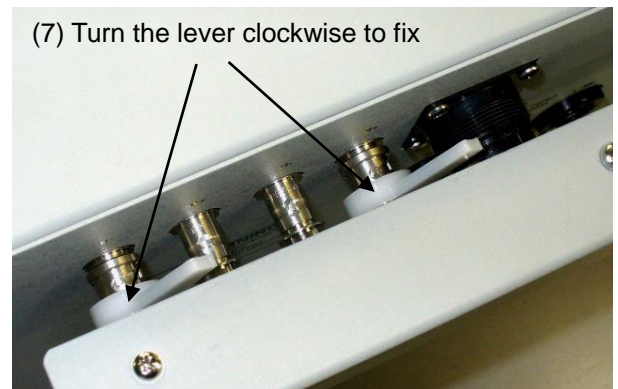

Fig. 4-10 Fixing SY-963

■ 4.5 Connecting DC Cable

- This section explains how to connect a DC cable, which is an accessory of SY-962.
- (1) Make sure that the power source of DC Bias Source SY-961 is **always turned OFF**.
- (2) Connect a short DC cable S and a long DC cable L by following Fig. 4-3. (See Fig. 4-11)

Insert a DC cable straight into the connector as far as it goes.

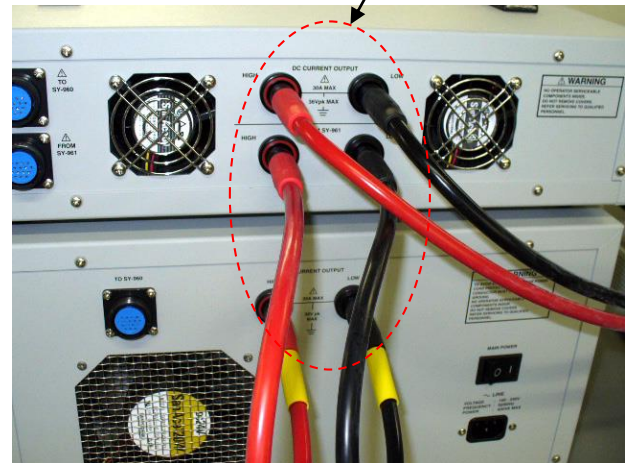

Fig.4-11 Connecting DC cable

■ 4.6 Connecting ACB Cable

- This section explains how to connect the ACB cable, which is an accessory of SY-962.
- (1) Make sure that the power source of DC Bias Source SY-961 is **always turned OFF**.
- (2) Connect a short ACB cable S and a long ACB cable L by following Fig. 4-3.
- (3) Fit the connector, and turn the ring clockwise to fix.
- (See Fig. 4-12)

Turn the ring clockwise to fix the ACB cable connector.

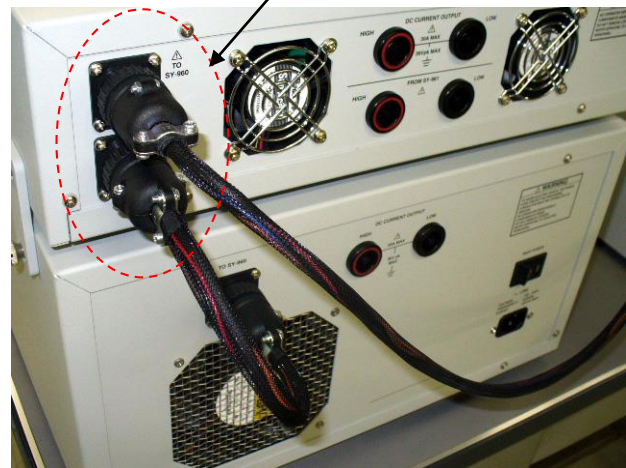

Fig. 4-12 Connecting ACB cable

■ 4.7 Turning the Power ON

- This section describes how to turn the power ON.
 - (1) Turn the main power switch in the rear of DC Bias Source SY-961 ON. (See Fig. 3-5)
 - (2) Turn the POWER switch in the front panel of DC Bias Source SY-961 ON. (See Fig. 3-4)
 - (3) Turn the main power switch of DC Bias Tester SY-960 ON. (See Fig. 3-1)
 - (4) Turn the power source of the power amplifier ON when using the power amplifier.
 - (5) Turn the power source of B-H ANALYZER ON to start. See Instruction Manual of the B-H ANALYZER main unit for operation.
 - (6) Warm up for at least 30 minutes.

■ 4.8 Turning the Power OFF

- This section describes how to turn the power source OFF. The reverse order of turning ON is applied to the order of turning OFF.
 - (1) Turn the power source of the power amplifier OFF when using the power amplifier.
 - (2) Turn the power source of B-H ANALYZER OFF. See Instruction Manual of the B-H ANALYZER main unit for operation.
 - (3) Turn the main power switch of DC Bias Tester SY-960 OFF. (See Fig. 3-1)
 - (4) Turn the POWER switch in the front panel of DC Bias Source SY-961 OFF. (See Fig. 3-4)
 - (5) Turn the main power switch in the rear of DC Bias Source SY-961 OFF. (See Fig. 3-5)

■ 4.9 Setting a Sample

- This section describes how to set a sample of surface mounting part.

- (1) Mount the surface mounting part on a dedicated printed-circuit board, an accessory of SY-960, shown in Fig. 4-13, by soldering.

* A hole on the rear of the dedicated printed-circuit board is a hole for sensor to measure the temperature of the part. Never cover the hole by any object that obstructs the measurement.

* We offer customized dedicated printed-circuit boards. Contact us for details.

* It is very dangerous to design a printed-circuit board by yourself. In designing a printed-circuit board, consideration must be given to connection to terminals, positional relationship with a temperature sensor, and an allowable current.

- (2) With the parts side facing up, securely connect the dedicated printed-circuit board to the P1, P2, S1, and S2 terminals on the sample table. (See Fig. 4-14)

* If connection of the terminal loosens during the measurement, higher than expected high voltage is generated, which may **cause a failure of this instrument and B-H ANALYZER**.

- (3) For a coil method of the sample, select the 1-coil method. (See ■4.13)

- This section describes how to set a sample of 2 coils.

- (1) Wind primary turns and secondary turns to the sample.
- (2) Securely connect the beginning of the primary turns winding to the P2 terminal and the end of the winding to the P1 terminal.
- (3) Securely connect the beginning of the secondary turns winding to the S2 terminal and the end of the winding to the S1 terminal.

* If connection of the terminal loosens during the measurement, higher than expected high voltage is generated, which **causes a failure of this instrument and B-H ANALYZER**.

- (4) Adjust the position of the sample so that the sample is placed on the IR sensor for toroid. (See Fig. 3-2)

* If the sample comes off the IR sensor, the temperature of the sample cannot be measured during the measurement.

- (5) For a coil method of the sample, select the 2-coil method. (See ■4.13)

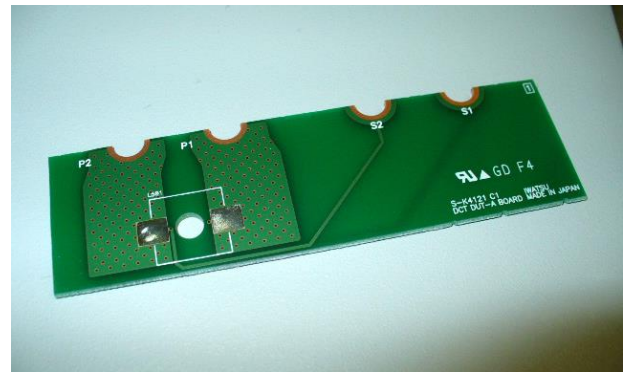

Fig. 4-13 Dedicated printed-circuit board

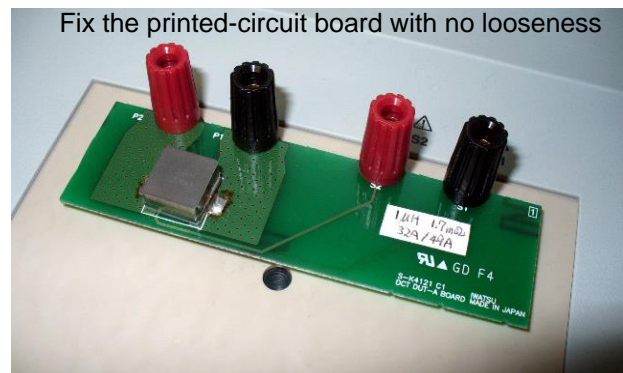

Fig. 4-14 Setting a dedicated printed-circuit board

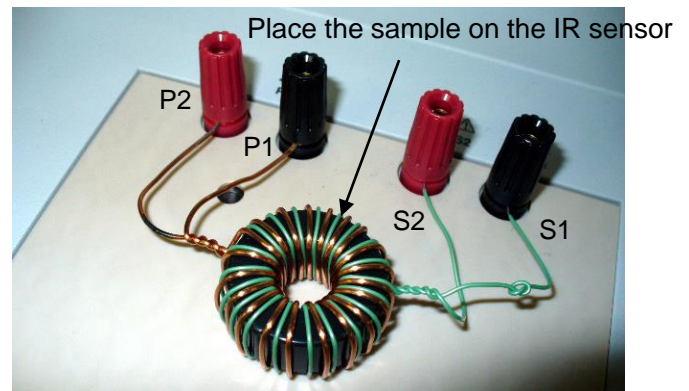

Fig. 4-15 Setting the sample

4.10 Setting the Overheat Temperature

- Set the overheat temperature of the sample. If one of the IR temperature sensors, located at two positions on the sample table, detects that the temperature exceeds the overheat temperature, the temperature display flashes and the current output of DC Bias Source is stopped if measurement is being conducted.

- (1) Press the 3-digits overheat protection switch of DC Bias Tester to set the overheat temperature in accordance with Table 4-1. The temperature set with this switch is 0 to 250 [°C]. We recommend that 50 [°C] at shipment is set for the preset temperature.

* Any temperature set over 250 [°C] is set as 250 [°C].

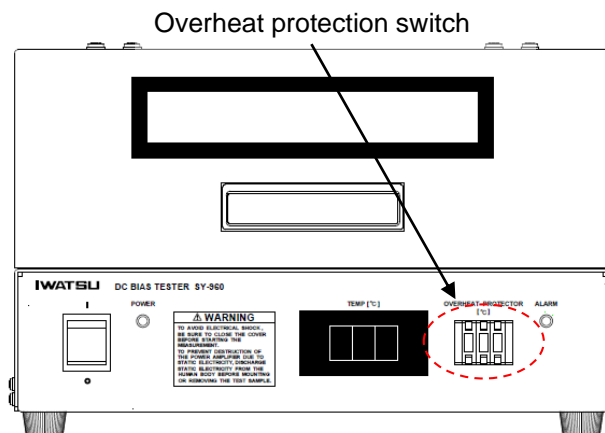





Fig. 4-16 Overheat protection switch

Table 4-1 Setting example of the overheat temperature

Temperature to set [°C]	Overheat protection switch		
	Third digit	Second digit	First digit
125	1	2	5
60	0	6	0

4.11 Checking Functions

- Check whether the DC Bias function is enabled.

- (1) Press  to display the Utilities screen.
- (2) Check that DC Bias Tester of Option is Enabled. (See Fig. 4-17)
- (3) Press  or  to close the Utilities screen.

* See the Instruction Manual of B-H ANALYZER main unit for other settings of the Utilities screen.

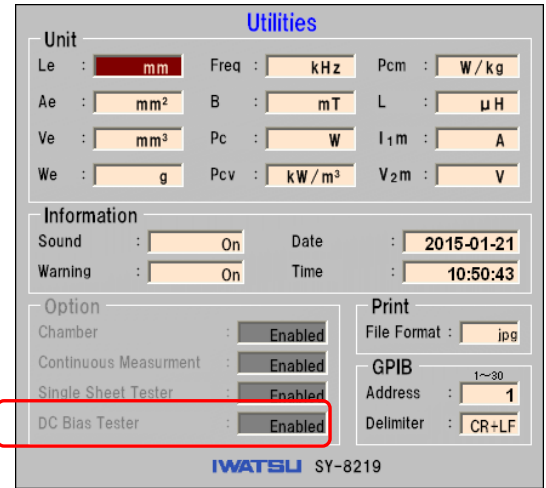



Fig. 4-17 Utilities screen

4.12 Selecting the DC Bias Measuring Mode

- Select DC Bias Tester for the measuring mode.

- (1) Press  to display the Mode menu.
- (2) Position an edit cursor on DC Bias and press  to determine the selection of the DC Bias measuring mode. (See Fig. 4-18)
- (3) The DC Bias measuring mode screen will be displayed. (See Fig. 4-20)

* A measuring mode of Option which is Disabled is grayed out and cannot be selected.

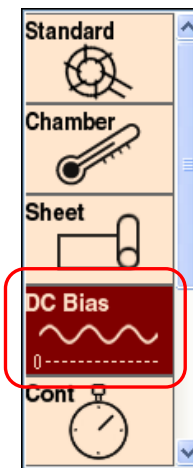







Fig. 4-18 Mode menu

4.13 Selecting a Coil Method of the Sample

- Select a coil method of the sample.

- (1) Press  to display the Configuration screen. (See Fig. 4-19)
- (2) Move the edit cursor to Coil of Measuring Method, and then press .
- (3) Select a coil method and then press  to determine the selection.
- (4) Press  or  to close the Configuration screen.

* Selecting a wrong coil method **cannot provide a collect measuring result.**

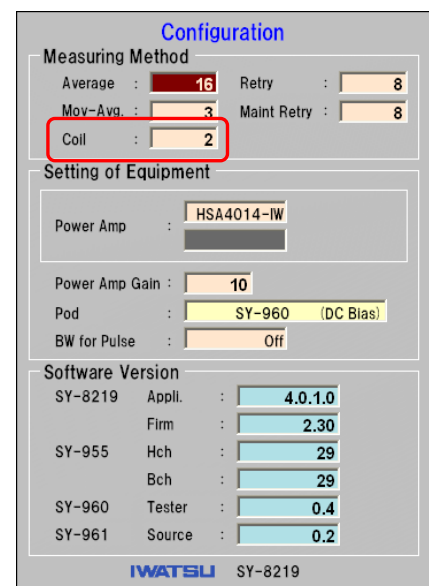

Fig. 4-19 Configuration screen

4.14 Measurement Screen

- This section explains the outline of the measurement screen of the DC Bias measuring mode.

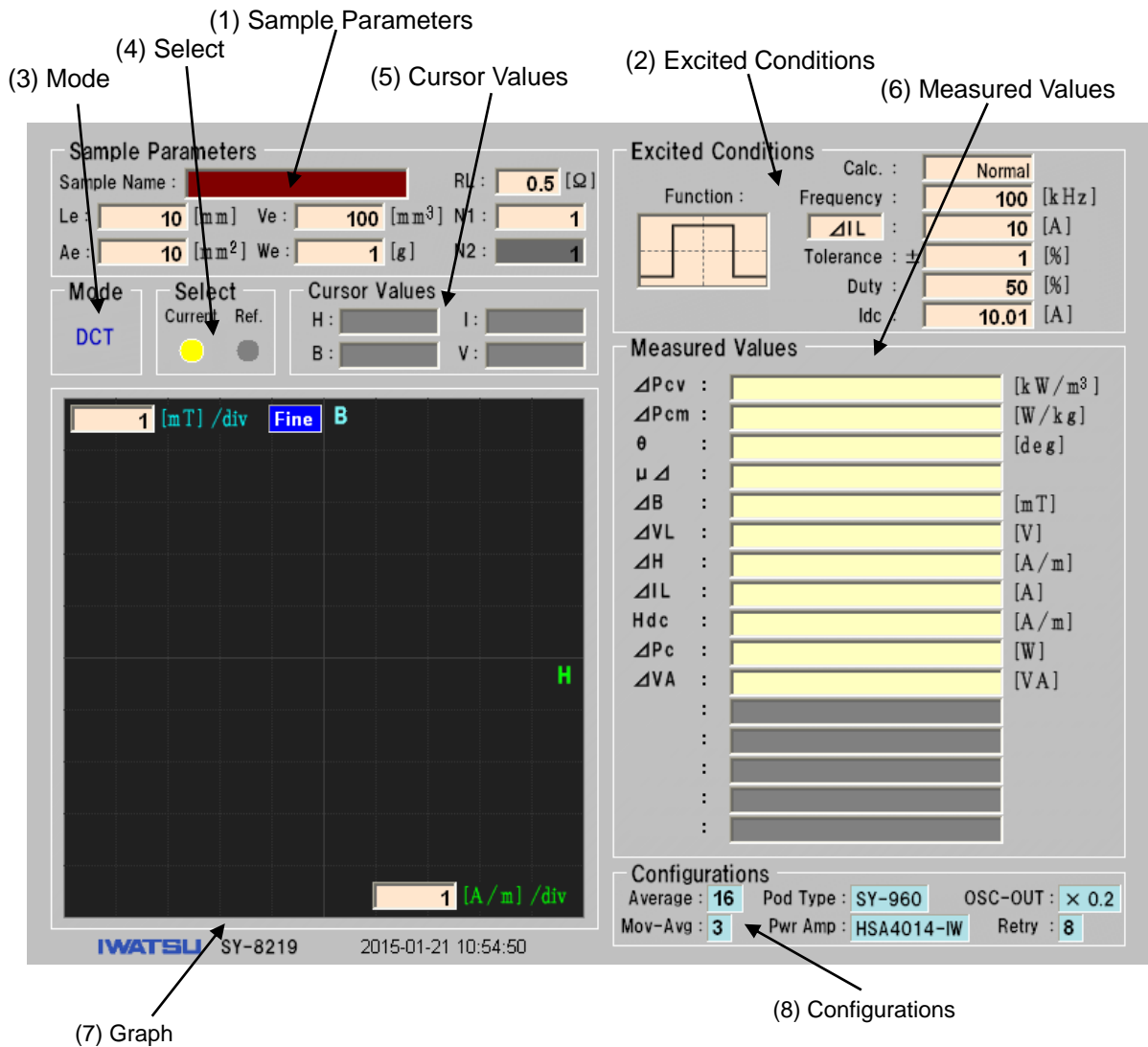



Fig. 4-20 Measurement screen

- Sample Parameters: sets the name and constants of the sample.
- Excited Conditions: sets measuring conditions.
- Mode: **DCT (DC Bias Tester)** is displayed to show clearly that it is in the DC Bias measuring mode.
- Select: indicates that the currently displayed graph is either Current (measured now) or Reference (stored graph).
- Cursor Values: displays cursor values when the cursor is displayed. Unit is same as in the graph.
- Measured Values: displays the measured value.
- Graph: shows a B-H graph or a time-base graph.
- Configurations: shows leading values set in the Configuration screen.

■ 4.15 Entering Constants of Sample

- Enter constants of sample of the measuring sample.
 - (1) Referring to Table 4-2, move the edit cursor to the Edit Box of a sample constant of Sample Parameters to enter, and then press  to determine the selection.





- (2) Popup Edit Box will open. Directly enter numeric value with ten keys, and then press . Alternatively, move the edit cursor to the numeric value to change, and then press  . Or rotate  to change numeric value, and then press  to determine the setting.

Table 4-2 Constants of sample

Item	Input rule	Explanation
Sample Name	Up to 20 characters	Name of the sample
RL	0.000 to 99.99	ESR of the sample * Unit is fixed to [Ω]. * It is enabled when 1-coil method is selected.
Le	0.001 to 99999	Effective length of magnetic path
Ae	0.001 to 99999	Effective net core area
Ve	0.001 to 99999	Effective volume
We	0.001 to 99999	Weight
N1	0.1 to 9999.9	Number of primary turns
N2	0.1 to 9999.9	Number of secondary turns * It is enabled when 2-coil method is selected.

* Enter the correct value for ESR **RL** of the sample. If a value which is far from the actual value is set, B-H ANALYZER cannot select a correct measuring range, and may not perform the measurement.

4.16 Setting Measuring Conditions







- Set measuring conditions.
 - (1) Referring to Table 4-3, move the edit cursor to Edit Box of a measuring condition of Excited Conditions to enter, and the press  to determine the selection.
 - (2) If Popup List opens, move the edit cursor to the item to set, and then press  to determine the setting.
 - (3) If Popup Edit Box opens, enter numeric directly with ten keys, and then press . Alternatively, move the edit cursor to the numeric value to change, and then press  . Or rotate  to change numeric value, and then press  to determine the setting.

Table 4-3 Measuring conditions

Items		Items that can be selected / input rules		Explanations
Function		Sine		Sinusoidal wave
		Pulse		Pulse wave
Calc.		Normal		Selects a calculation mode.
		μ		
Frequency	Sinusoidal wave	SY-8218	10 kHz to 3 MHz	Sets frequency of excitation signal.
	Pulse wave	SY-8219	10 kHz to 1 MHz	
Fixed Parameter (Target parameter)		ΔB (Increment magnetic flux density)	0.001 to 99999	Selects a target parameter of measurement, and set the value as peak-to-peak value (amplitude x2). * A guideline of the minimum value of ΔIL that can be controlled with this instrument is about 30 to 50 [mA] .
		ΔH (Strength of increment magnetic field)		
		ΔIL (Increment current)		
		ΔVL (Increment voltage)		
Tolerance		0.1 to 100%		End the measurement when the actually measured target parameter value has reached within X [%] of the value set in the target parameter. Set this Tolerance X.
Duty		10 to 90%		Sets Duty of pulse wave.
Idc		0.00 to 30.0		Sets the value of direct current output from DC Bias Source SY-961. * Unit is fixed to [A]. * There is a limitation at the time when direct current can be continuously output. (Refer to Fig.4-21.) SY-961 stops outputting when this time is exceeded, and W71 is displayed on the DC CURRENT display. (Refer to Table.3-2.) It cancels the measurement when measuring.

* If conditions to perform the measurement cannot be determined, we recommend that you **specify ΔIL, slowly increment ΔIL and Idc to perform the measurement, and observe loss of the sample and an exothermic state.**

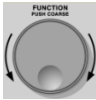
* Back electromotive force V, represented in formula (4.1), is generated at both ends of the sample if **the sample comes to an open electrical state due to damage, etc., during the measurement. The voltage will instantly exceed the maximum measurement voltage 200 [V] of this instrument** if the time to become open is quick. Carefully decide the measuring conditions to prevent the damage of sample, etc.

If the current I (=IL+Idc) flowing in the sample (inductance L) decreases dI [A] during the time dt [s], the voltage is:

$$V = -L \frac{dI}{dt} \quad (4.1)$$

[Example] V=-1 [kV] when L=10 [μH], dt=0.1 [μs], and dI=10 [A].

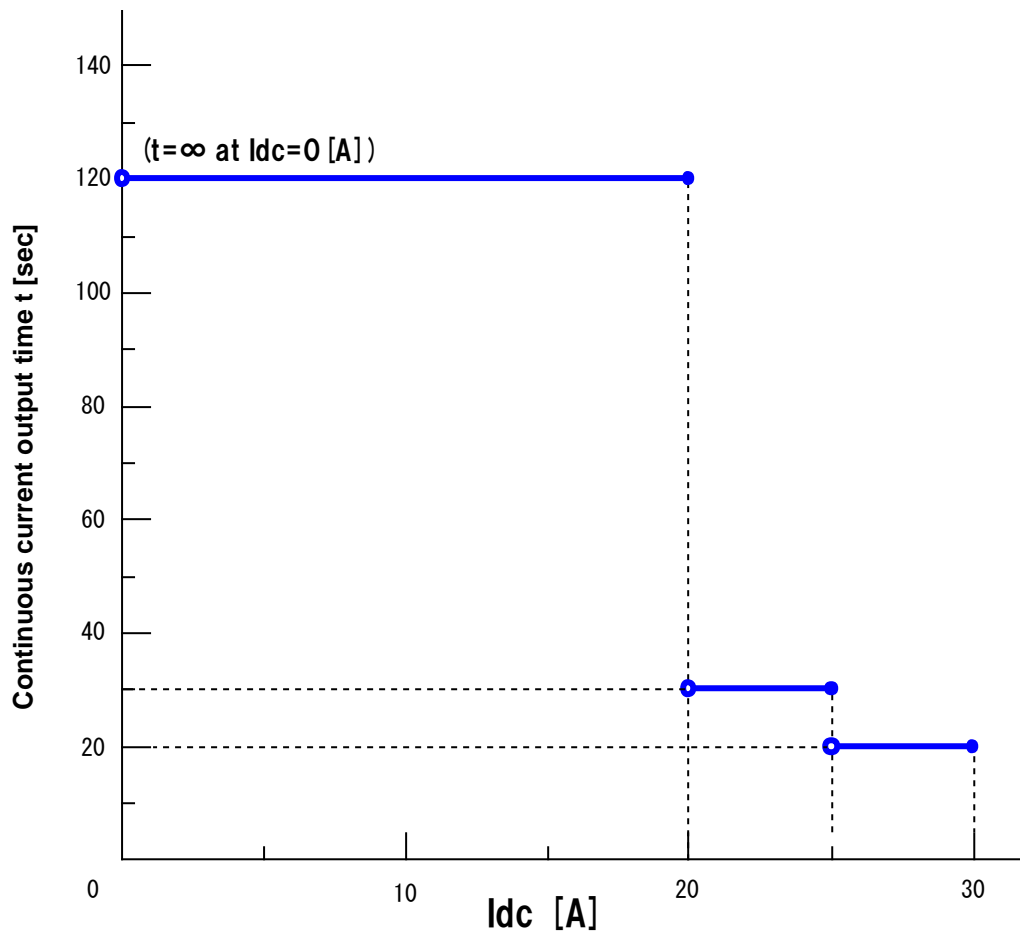

Fig. 4-21 Continuous current output time - I_{dc}

4.17 Measurement

- Perform the measurement.

(1) Check again that the sample is securely connected to the P1, P2, S1, and S2 terminals.

(2) Securely close the cover of DC Bias Tester SY-960.

* Measurement cannot be performed with the cover opened.

(3) Press  to start the measurement. A message "Measuring!" blinks on the graph screen.

* During measurement, pay attention to the temperature display of the sample.

* →When the power amplifier is used, if **OVLD (overload) lamp turns on** during the measurement, immediately turn OFF OUTPUT of the power amplifier to stop the measurement. Otherwise, the power amplifier will break down.

(4) When the measurement completes successfully, the message "Measuring!" disappears and then the measurement result will be displayed.

(5) After the measurement is started, to stop the measurement forcibly, press . At this time, the measurement result may display * if the measurement cannot be performed.

* If an error or a Warning is displayed, see section 7.1 of Instruction Manual of the B-H ANALYZER main unit.

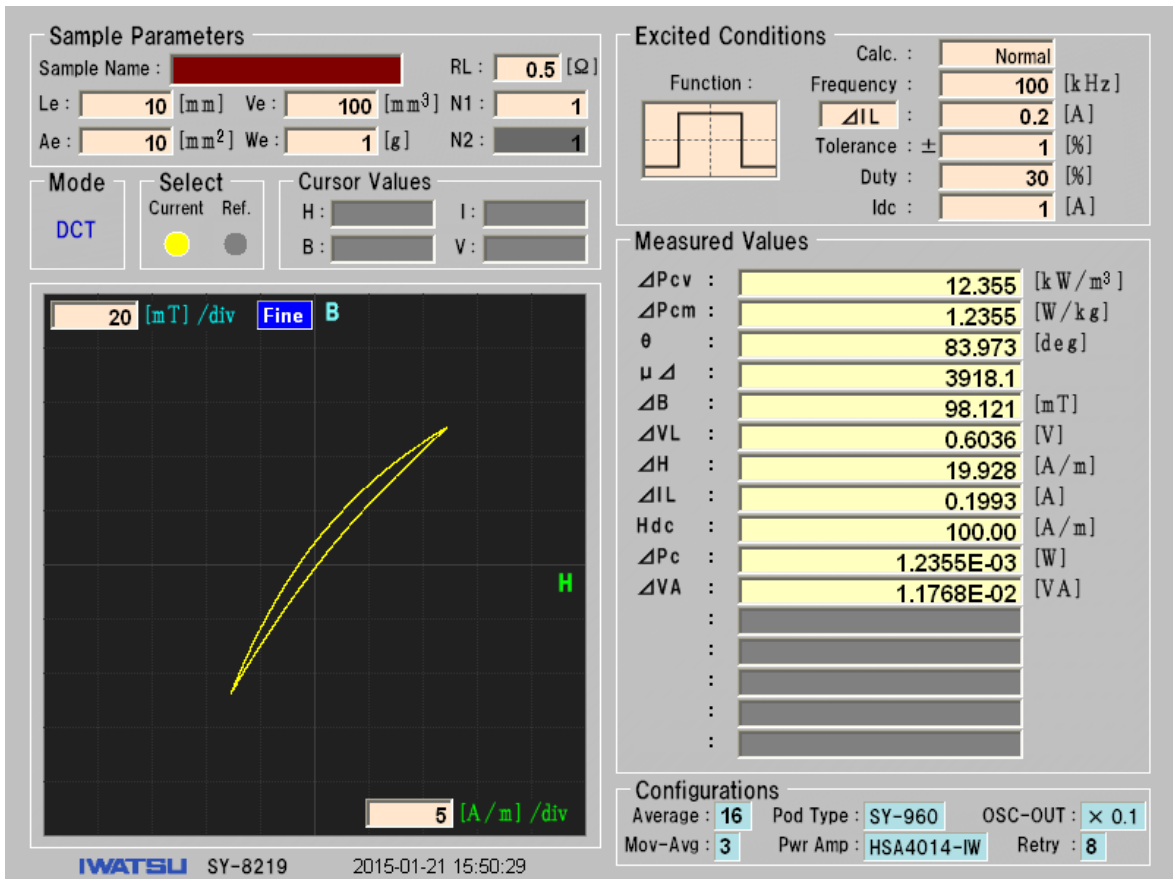

Fig. 4-22 Measurement screen

■ 4.18 Switching Graph

- Similar to the measuring mode that is provided as a standard, a graph to be displayed can be switched to a B-H graph and a time-base graph. See the Instruction Manual of B-H ANALYZER main unit for operation.

■ 4.19 Cursor Measurement

- Similar to the measuring mode that is provided as a standard, a cursor measurement can be performed. See the Instruction Manual of B-H ANALYZER main unit for operation.

■ 4.20 Enlargement / Reduction of Graph

- Similar to the measuring mode that is provided as a standard, a graph can be enlarged and reduced. See the Instruction Manual of B-H ANALYZER main unit for operation.

■ 4.21 Reference Function

- Similar to the measuring mode that is provided as a standard, B-H ANALYZER has a reference function, and can store a result of one measurement. See the Instruction Manual of B-H ANALYZER main unit for operation.

■ 4.22 USB Memory Output of Screen Hard Copy

- Similar to the measuring mode that is provided as a standard, a hard copy of the measurement screen can be output to a USB memory. See the Instruction Manual of B-H ANALYZER main unit for operation.

■ 4.23 Save / Read the Data

- Similar to the measuring mode that is provided as a standard, measurement data, etc. can be saved in a USB memory. Measurement data etc. can be read from the USB memory. See the Instruction Manual of B-H ANALYZER main unit for operation.

Chapter 5 Maintenance

■ 5.1 Daily Maintenance

- Maintain this instrument daily to keep its measurement accuracy and precision.
 - (1) Regularly remove dust from two IR temperature sensors of DC Bias Tester SY-960 with the blower brush which is an accessory of SY-960. A dusty sensor cannot measure a temperature accurately.
 - * The polyethylene sheet to protect the sensor is fragile. Do not use any items other than the blower brush which is an accessory of SY-960 to clean the sensor.
 - (2) Lightly wipe dirt from this instrument with a soft cloth moistened with small amount of dilute neutral detergent. Never use organic solvent. Discoloration or corrosion may occur.

■ 5.2 Calibration

- Measurement accuracy and precision of this instrument may fluctuate by long-term use, depending on usage environment and frequency. We recommend that you calibrate this instrument at least once a year. Contact Iwatsu office or our sales distributors for details.

Chapter 6 Specifications

■ 6.1 DC Bias Tester SY-960

Table 6-1 Specifications of SY-960

Items		Specifications			
Power supply voltage		24 V DC, 12 V DC, 5.3 V DC (Supplied from SY-961 via SY-962)			
Measurement	Measuring frequency	Sinusoidal wave	When connecting to SY-8218: 10 kHz to 3 MHz When connecting to SY-8219: 10 kHz to 1 MHz		
		Pulse wave	10 kHz to 1 MHz (Duty 10 to 90%)		
	Measuring temperature	0°C to 250°C			
Signal detection	Current detection resistance	About 1 Ω			
	Maximum measuring current	±6 A			
	Maximum measuring voltage	±200 V			
Measurement accuracy	Phase angle	Frequency	1-coil		
			1 Ω>R _L ≥0.5 Ω, 10 μH≥L≥0.5 μH	R _L <0.5 Ω or 0.1 μH<L<0.5 μH	2-coil
		10 kHz to 50 kHz	±0.15 deg	±0.80 deg	±0.20 deg
		50.1 kHz to 100 kHz	±0.15 deg	±0.40 deg	±0.20 deg
		101 kHz to 500 kHz	±0.15 deg	±0.20 deg	±0.15 deg
		501 kHz to 1 MHz	±0.20 deg	±0.25 deg	±0.25 deg
	1.01 MHz to 3 MHz	±0.50 deg	±0.50 deg	±0.30 deg	
		* 1.01 MHz to 3 MHz is applicable when connecting to SY-8218 only. * Measured value of SY-95x standard POD is set as a standard			
	Amplitude	±2% (Typical value; when connecting to SY-8218/SY-8219; at f=10 kHz, 200 mA, 200 mV range or higher)			
	Core loss	1-coil method (1 Ω>R _L ≥0.5 Ω, 10 μH≥L≥0.5 μH) ±5.6% 1-coil method (R _L <0.5 Ω or 0.1 μH<L<0.5 μH) ±12.3% 2-coil method ±6.1% (Calculation value of θ=80°; at frequency, 10 kHz, 200 mA, 200 mV range or higher)			
	Temperature	±3°C (±4°C for a temperature 240°C or higher) (Reference)			
Environmental conditions	Operating temperature	+5°C to +35°C			
	Specification guarantee temperature	+18°C to +28°C			
	Operating humidity	Below the moisture amount of 85% RH (+35°C, no dew condensation)			
	Warming-up time	Accuracy of current is a guaranteed value at least 30 minutes after the power source is turned on.			
Dimensions		330(W) × 320 (D) × 200 (H) Projections are not included.			
Weight		About 6.7 kg			
Accessories		DCT cable (SY-963): 1 pcs PCB1528-030: 1 pcs PCB5650-079: 1 pcs Thumbscrew for the terminal block: 2 pcs Blower brush: 1 pcs Accessories storage box: 1 pcs Instruction Manual CD: 1 pcs User's Guide (A4 version): 1 set			

■ 6.2 DC Bias Source SY-961

Table 6-2 Specifications of SY-961

Items		Specifications
Power supply	Power supply voltage	100 to 240 V AC
	Range of frequency	50 Hz / 60 Hz
	Power consumption	Maximum 640 VA (When connecting to SY-962)
Output	Current I_{dc}	0.00 to 30.0 A DC
	Current resolving power	0.01 A
	Current accuracy	$\pm 1\%$ of reading ± 20 mA
	Compliance voltage	Maximum 10 V (between H and L)
Environmental conditions	Operating temperature	+5°C to +35°C
	Specification guarantee temperature	+18°C to +28°C
	Operating humidity	Below the moisture amount of 85% RH (+35°C, no dew condensation)
	Warming-up time	Current accuracy is a guaranteed value at least 30 minutes after the power source is turned on.
Dimensions		420 (W) × 480 (D) × 221 (H) Projections are not included.
Weight		About 15.3 kg
Accessories		Power supply cord: 1 pcs Cord strap: 1 pcs

■ 6.3 AC Blocker SY-962

Table 6-3 Specifications of SY-962

Items		Specifications
Power supply voltage		24 V DC (Supplied from SY-961)
Inductance		About 1.68 [mH] $\pm 15\%$ (between H and L)
Maximum input current		30 [A]
Current ripple		30 [mA _{p-p}] or less
Maximum input voltage		36 [V _{pk}]
Environmental conditions	Operating temperature	+5°C to +35°C
	Specification guarantee temperature	+18°C to +28°C
	Operating humidity	Below the moisture amount of 85% RH (+35°C, no dew condensation)
Dimensions		420 (W) × 480 (D) × 110 (H) Projections are not included.
Weight		About 14.0 kg
Accessories		Joint fittings: 4 pcs ACB cable L: 1 pcs ACB cable S: 1 pcs DC cable L red / black: 1 each DC cable S red / black: 1 each

■ 6.4 DC Bias Tester SY-960 Appearance

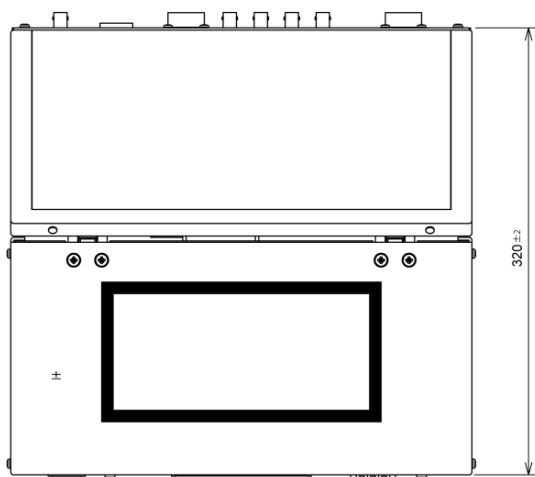

Unit: mm

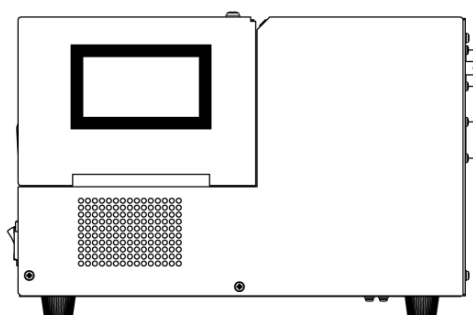
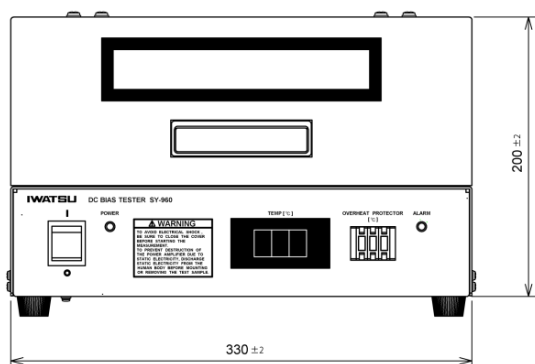

■ 6.5 DC Bias Source SY-961 Appearance

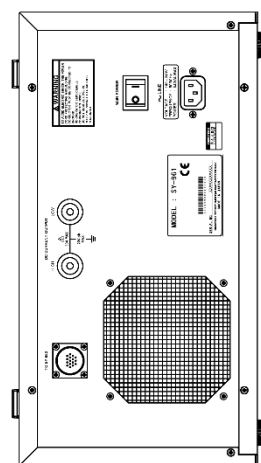
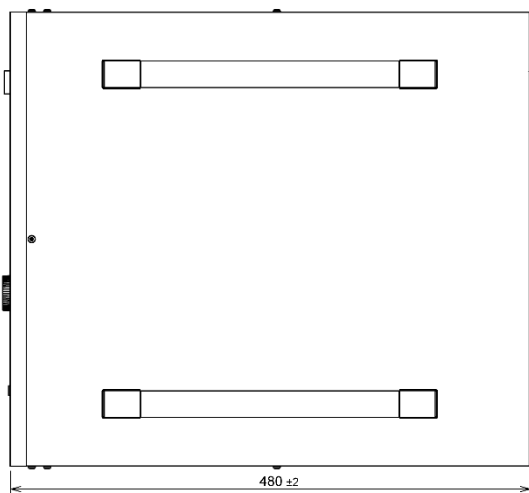
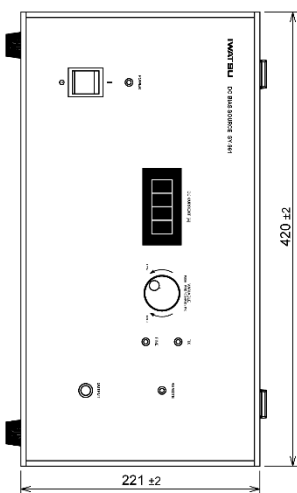

Unit: mm

6.6 AC Blocker SY-962 Appearance

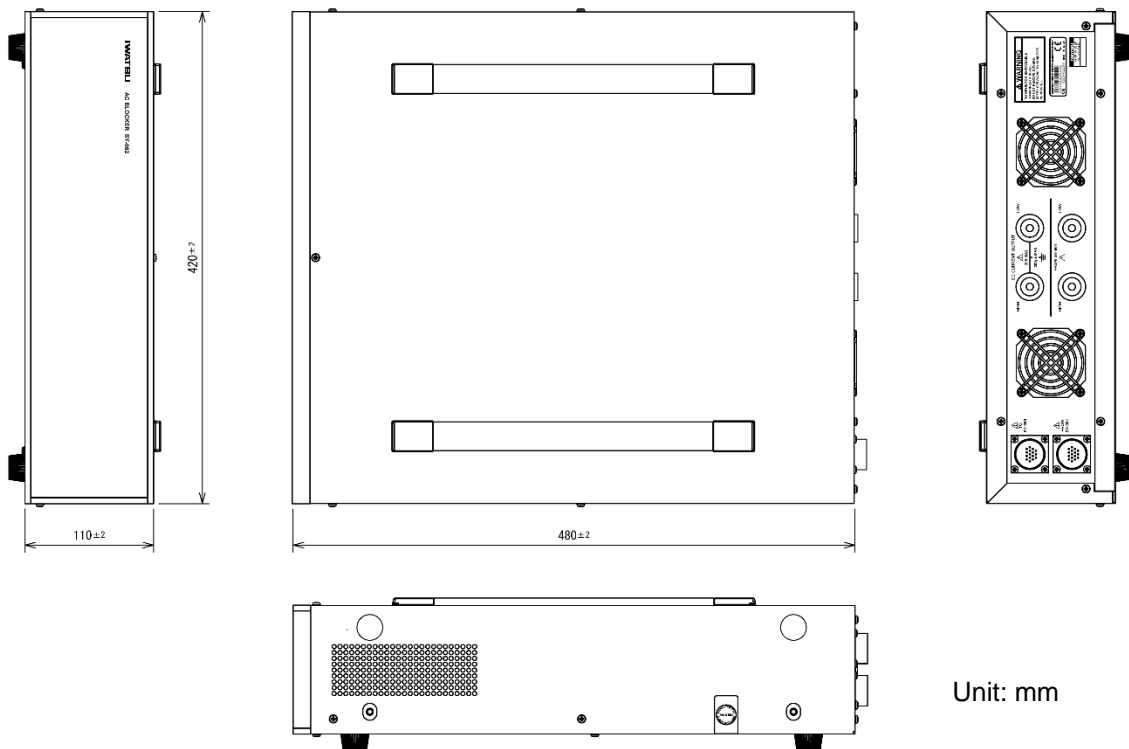

Unit: mm

6.7 Dimension Diagram of Measuring Table

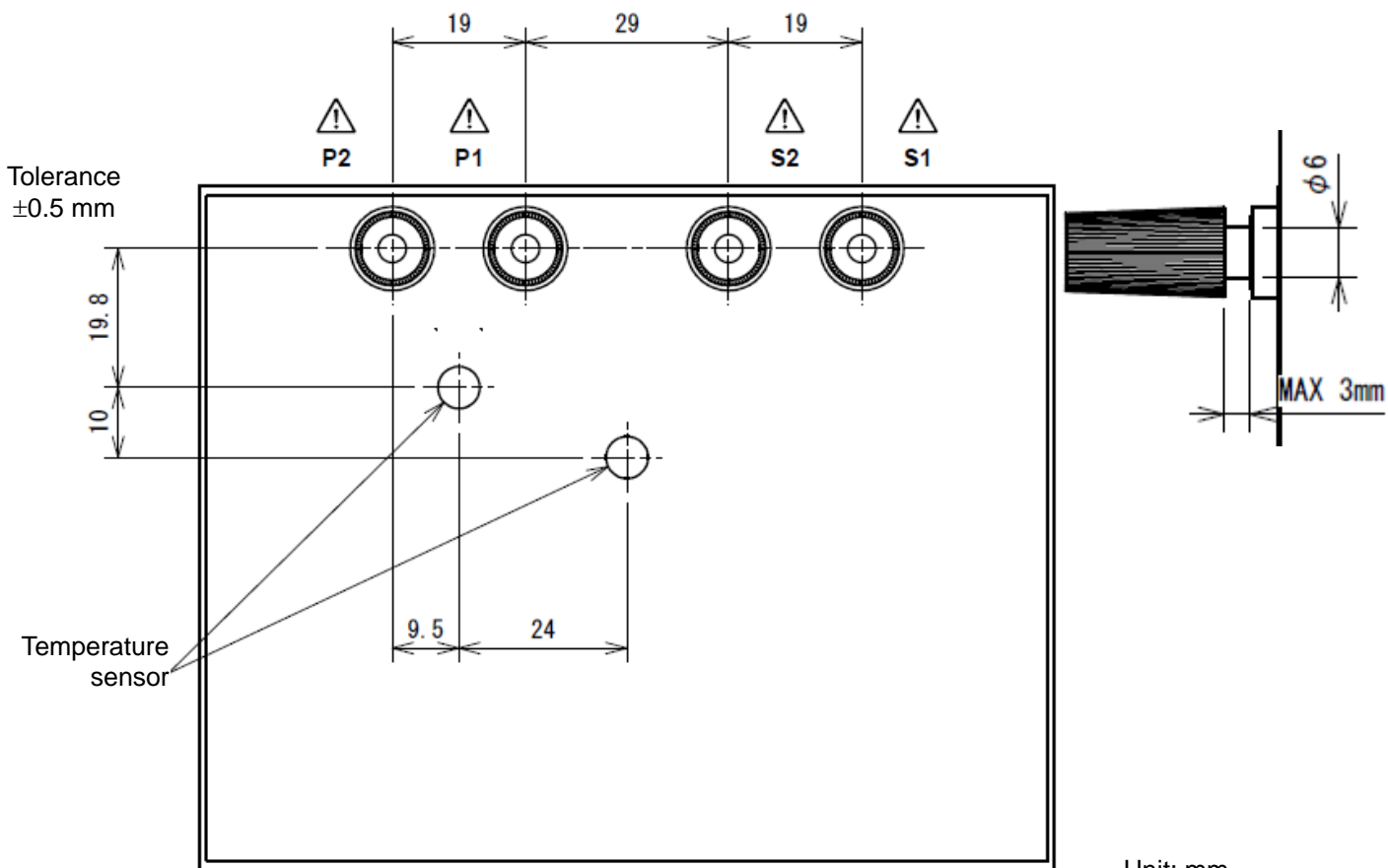

Unit: mm

■ 6.8 Certification Standards

This instrument meets requirements of EMC Directive 2014/30/EU and Low Voltage Directive 2014/35/EU.

EMC Directive

Emission

EN 61326-1: 2013 (Class A)

EN 61000-3-2: 2014

EN 61000-3-3: 2013

Immunity

EN 61326-1: 2013

Low Voltage Directive

Safety

EN 61010-1: 2010 (Third Edition)

Overvoltage category

II

Pollution degree

2

IWATSU TEST INSTRUMENTS CORPORATION

Address : 7-41 Kugayama 1-chome Suginami-ku Tokyo, 168-8511 Japan

Phone : +81 3 5370 5483

Facsimile : +81 3 5370 5492

Homepage : <http://www.iti.iwatsu.co.jp>

SY-960/SY-961/SY-962